



POLARIS®

SPORTSMAN



2016

ACCESSORIES, RIDING GEAR & GARAGE

INTERNATIONAL VERSION

POLARIS®

ENGINEERED PARTS
ACCESSORIES & APPAREL

ENGINEERED TO PERFORM

The Polaris® Sportsman® is engineered to be the hardest working, smoothest riding ATV available. That same mentality produces our Polaris Engineered Parts and Accessories™. We understand what riders demand from their equipment, because we're riders ourselves. From the very start, our accessories are designed, rigorously tested and meticulously fine-tuned alongside the Sportsman®, making sure that they are completely in sync with one-another to elevate your off-road experience.



"POLARIS ENGINEERED PARTS AND ACCESSORIES™ ARE MADE BY THE SAME PEOPLE WHO DESIGN THE VEHICLES. NOBODY KNOWS THESE MACHINES BETTER THAN US."

— CLINT J., POLARIS DESIGNER

2016 POLARIS SPORTSMAN®

ACCESSORIES, RIDING GEAR & GARAGE

Polaris Engineered™	01
Innovation	02-03
Sportsman® Accessory Solutions	04-07

ACCESSORIES

Winches	08-11
Plows	12-15
Tracks	16-17
Bumpers & Guards	18-21
Tires & Wheels	22-25
Windshields	26-27
Racks	28-29
Storage	30-33
Lighting	34-35
Tech & Electronics	36-38
Audio	39

SCRAMBLER®

40-41

RIDING GEAR

42-43

Helmets	44-45
Goggles	46
Gloves & Jerseys	47
Protection	48
Hats & Base Layers	49
Men's Casual Apparel	50-51
Women's Casual Apparel	52-53
Youth Casual Apparel	54
Sizing Charts	54
OGIO® Bags	55
Gifts	55

GARAGE

56-57

Tool Chests	58
Shop Products	59
Generators & Battery Care	60
Trailers, Ramps & Covers	61
Parts	62
Fuel Treatments	63
Oils & Lubricants	64-65



SEE POLARIS ENGINEERED™ VIDEOS
AT POLARIS.COM/ATVACCESSORIES

INNOVATION NEVER RESTS

NEW FOR 2016

Over the past year, we've enhanced our existing products and created new accessories in every category, all with the goal of helping you to get the most out of your Sportsman®.

LOCK & RIDE® XL STORAGE BOX

PAGE 30

POLARIS NORTHSTAR™ COOLER

PAGE 32

WHEELS & TIRES

PAGE 22-25

MADE TO MAKE IT YOUR OWN

LOCK & RIDE® ACCESSORIES

An industry exclusive, Polaris® Lock & Ride® system has revolutionized off-road vehicle customization. Lock & Ride® products are specifically designed to be installed quickly and without hassle. Accessory integration takes mere minutes, and doesn't require any special tools. Best of all, there is no sacrifice in performance. Lock & Ride® accessories won't rattle or shake, and are guaranteed to fit snugly and properly.



PRE-WIRED FOR WINCHES

Every 2016 Sportsman® comes winch-ready, equipped with factory-installed wiring built into the chassis. Just attach the quick clip connection points and hook up the power cables to the battery, and your winch is powered and ready to go.



FACTORY-INSTALLED MOUNT FOR PLOWING

The biggest snowfalls have met their match. All 2016 Sportsman® models come with a factory-installed mount to accept your plow system. Attaching and removing your plow takes just a few minutes.

YOUR OFF-ROAD VEHICLE FOR EVERY OCCASION

Whether you're knocking out the to-do list, pursuing big game, or out for a day on the trail, there are Polaris Engineered Accessories™ equipped for your Sportsman® to take it on.



WORK

Your daily tasks just got a whole lot easier.

HUNT

Gear up for the hunt.



TRAIL

Tackle all of the twists and turns you can find.

ROOM FOR MORE – LOCK & RIDE® XL STORAGE BOX – PG 30

SECURED LOAD – FRONT RACK EXTENDER – PG 28

ALWAYS PREPARED - WINCH - PG 10-11

WORK

For those that get things done. Our wide range of easy-to-install accessories transform your Sportsman® into the most versatile tool in the shed.

WORK SOLUTION

- › LOCK & RIDE® XL STORAGE BOX | PAGE 30 | 2881128-070
- › LOCK & RIDE® XL STORAGE BOX MOUNT | PAGE 30 | 2881331
- › XL TOOL BAG | PAGE 30 | 2881129
- › SPORTSMAN® 570 FRONT RACK EXTENDER | PAGE 29 | 2879716
- › SPORTSMAN® 570 REAR RACK EXTENDER | PAGE 29 | 2879717



The above accessory collections are recommendations to improve your riding experience in specific environments, but Polaris® encourage riders to mix and match accessories however you see fit. To assemble your own accessories, visit Polaris.com.

HUNT

Your next trophy is out there. Go get it. Carry all of your hunting equipment with Polaris Engineered™ storage. Rugged gun boots and mounts allow you to safely transport your favorite firearm.

HUNT SOLUTION

- › SPORTSMAN® 570/ETX FRONT BRUSHGUARD | PAGE 19 | 2879714
- › POLARIS® HD 2500 LB. WINCH | PAGE 11 | 2880432
- › LOCK & RIDE® GUN BOOT MOUNT | PAGE 33 | 2879888
- › POLARIS® GUN BOOT BY KOPLIN® | PAGE 33 | 2872677
- › SPORTSMAN® 570 FRONT RACK EXTENDER | PAGE 29 | 2879716
- › SPORTSMAN® 570 REAR RACK EXTENDER | PAGE 29 | 2879717



SECURED LOAD – FRONT RACK EXTENDER - PG 28



A HELPING HAND - WINCH - PG 11

GOT YOUR BACK – REAR BRUSHGUARD - PG 18

CLEAR CHOICE - WINDSHIELDS - PG 27

FULL PROTECTION - FRONT BRUSHGUARDS - PG 18

LIGHT IT UP - 12" LIGHT BAR - PG 35

TRAIL

Enjoy the trails knowing that all Polaris Engineered Accessories™ are designed to fit your vehicle perfectly and ensure the most comfortable ride possible.

TRAIL SOLUTION

- › SPORTSMAN® XP FRONT BRUSHGUARD | PAGE 18 | 2878709
- › SPORTSMAN® XP REAR BRUSHGUARD | PAGE 18 | 2878710
- › LOCK & RIDE SPORTSMAN XP WINDSHIELD | LOW BLACK | PAGE 27 | 2880541-070
- › OGIO® SEMI-RIGID REAR BAG | PAGE 32 | 2879911
- › 12" LIGHT BAR | PAGE 35 | 2879500
- › UNIVERSAL LED HARNESS | PAGE 35 | 2879863



The above accessory collections are recommendations to improve your riding experience in specific environments, but Polaris® encourage riders to mix and match accessories however you see fit. To assemble your own accessories, visit Polaris.com.

PULL YOUR WEIGHT

No Sportsman® is complete without a winch. With heavy work applications and a backup plan for compromising conditions, a winch is the most versatile accessory you can buy. It is so popular among riders that 7 out of 10 Sportsman® owners equip their ride with a winch.



HEAVY-DUTY PULLING POWER FOR YOUR JOB

DESIGNED FOR POLARIS® VEHICLES

- Integrated mounting locations for a perfect fit

HIGHEST QUALITY MATERIALS

- Steel spools and cut metal gears for greater durability
- Fully-sealed contactor, motor and drive train keep water out
- Corrosion-resistant finish withstands the elements

EXTENSIVE LAB AND FIELD TESTING

- Contactors, controls and winch assemblies tested 10,000+ cycles
- Rigorous performance testing in labs and in the field ensure your winch works when you need it most
- Strength testing ensures superior driveline strength

DESIGNED SPECIFICALLY FOR YOUR VEHICLE

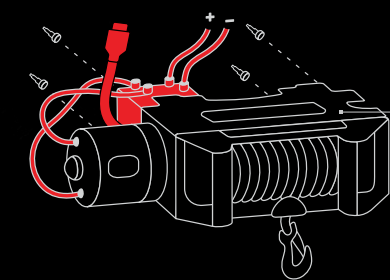

QUALITY ENGINEERED WINCH

- Polaris® winches are perfectly fit for your vehicle
- Pre-mounted contactor reduces installation time from hours to minutes
- Easy four bolt installation - Just match up the designated mounting points on the vehicle chassis with the winch mounting points and secure bolts

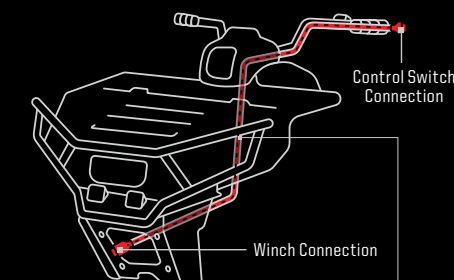

PRE-WIRED CHASSIS

- Every 2016 Polaris Sportsman® model has a factory installed wire built into the vehicle chassis, so your vehicle is 100% ready for a Polaris Engineered™ winch
- No plastic cutting or modification required
- Quick clip connection points for easy wire joining
- Simply connect power cables to battery for a power source

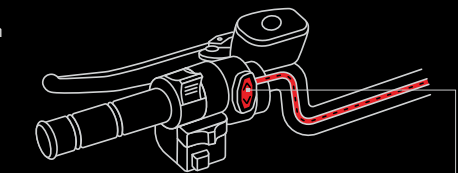

IMPROVED HANDLEBAR CONTROL

- Handlebar switch fastens on with two screws and one quick clip wire connection
- Positioned for intuitive control while riding

BUILT IN INTEGRATION REDUCES INSTALLATION TIME COMPARED TO AFTER MARKET BRANDS



HD HEAVY DUTY SERIES

The HD line delivers industry-leading quality and durability with best-in-class value – powered by quality features including sealed motors and contactors, a roller fairlead, wired remote control and proven pulling power.

WINCH USES



Assist another vehicle that finds itself stuck



Moving heavy objects such as fallen trees

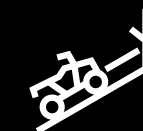

Allows the vehicle it's attached to remove itself from extremely difficult terrain/conditions



Essential part of plow system

WINCHES



WARN® PROVANTAGE WINCHES



WARN® PROVANTAGE 3500 LB. WINCH

- Powerful torque and legendary WARN® reliability, engineered for Polaris® vehicles
- Premium power with 3,500-pounds of pulling capacity
- Full-sealing for maximum water resistance
- Patented roller disc brake for assured holding power
- Limited Lifetime drivetrain warranty, 3 year electrical
- Includes all components required for installation

» 2880594
MY15-16 SPORTSMAN® VEHICLES



WARN® PROVANTAGE 2500 LB. WINCH

- Built to meet the demanding standards set by the WARN® and Polaris® names
- Reliable 2,500-pound pulling capacity
- Full-sealing for maximum water resistance
- Patented roller disc brake for assured holding power
- Limited Lifetime drivetrain warranty, 3 year electrical
- Includes all components required for installation

» 2880595
MY 15-16 SPORTSMAN® VEHICLES



Engineered and built exclusively for Polaris® by WARN Industries®, these winches deliver absolute reliability and the highest performance. Backed by the industry-leading WARN® Limited Lifetime Warranty.

HD WINCHES

HD HEAVY DUTY SERIES

3500 LB. WINCH



POLARIS® HD 3500 LB WINCH

- Maximum power with 3,500-pounds of pulling capacity
- 50-feet of 5mm premium high-strength synthetic rope
- Fully integrated design - installs to vehicle quickly and easily
- Includes all components required for installation
- 1-year warranty
- Performance upgrades (auto stop, wireless remote and plow rope) sold separately

» 2880435
SPORTSMAN® XP 850/1000, SCRAMBLER® MY 13-16

» 2880434
SPORTSMAN® 570 MY 14-16, SPORTSMAN® 570 SP MY 15-16, SPORTSMAN® ETX MY 15, SPORTSMAN® 450 HO MY 16



HD HEAVY DUTY SERIES

2500 LB. WINCH



POLARIS® HD 2500 LB WINCH

- Maximum power with 2,500-pounds of pulling capacity
- Fully integrated design - installs to vehicle quickly and easily
- 50-feet of 3/16" high strength steel cable
- Includes all components required for installation
- 1-year warranty
- Performance upgrades (auto stop, wireless remote and plow rope) sold separately

» 2880433
SPORTSMAN® XP 550/850/1000, SCRAMBLER® MY 13-16

» 2880432
SPORTSMAN® 570 MY 14-16, 570 SP MY 15-16, SPORTSMAN® ETX MY 15, SPORTSMAN® 450 HO MY 16

RETRO-FITTING WINCH WIRE HARNESS

- Direct to harness connections for older Sportsman® models
- Simplifies installation, no cutting or splicing
- Required for Polaris® Sportsman® (MY 10-14)

» 4015094
SPORTSMAN® 400/500/800/570/570 SP, SPORTSMAN® ETX, SPORTSMAN® XP 850/1000



"THE BEST PIECE OF EQUIPMENT YOU CAN HAVE IS A WINCH. IT SEEMS LIKE EVERY TIME WE'RE OUT IN THE WOODS, WE USE OUR WINCH."

— MICHAEL C., POLARIS OWNER

WINCH ACCESSORIES



SYNTHETIC WINCH ROPE

- Polaris® winch ropes are designed to work with the Polaris® winch of the same rating
- Always use the rope that is sized appropriately for your winch

» 2878888
POLARIS® HD 2500 AND 3500 LB. WINCHES

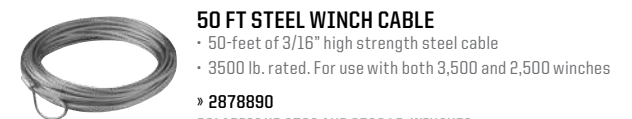

50 FT STEEL WINCH CABLE

- 50-feet of 3/16" high strength steel cable
- 3500 lb. rated. For use with both 3,500 and 2,500 winches

» 2878890
POLARIS® HD 2500 AND 3500 LB. WINCHES



POLARIS® WIRELESS WINCH REMOTE

- Allows for remote operation of Polaris® HD winch
- Up to 50-foot range with LED indicator
- Provides for safer operation of winch in retrieval situations
- Direct plug and play operation

» 2879316
POLARIS® ATV WINCH KITS

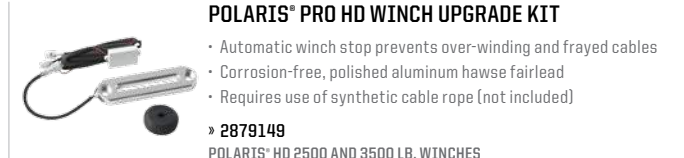

POLARIS® PRO HD WINCH UPGRADE KIT

- Automatic winch stop prevents over-winding and frayed cables
- Corrosion-free, polished aluminum hawse fairlead
- Requires use of synthetic cable rope (not included)

» 2879149
POLARIS® HD 2500 AND 3500 LB. WINCHES
Requires use of synthetic rope (not included)

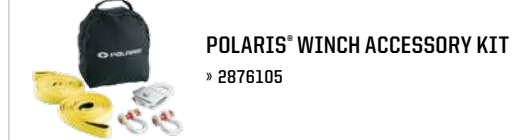

POLARIS® WINCH ACCESSORY KIT

» 2876105

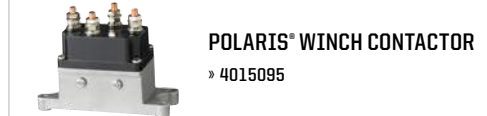

POLARIS® WINCH CONTACTOR

» 4015095

POSITIVE PUSH

Clearing the driveway just got a lot more fun. By combining the power of the Sportsman® with a complete selection of heavy-duty blades, you'll make quick work of even the biggest snowfalls.

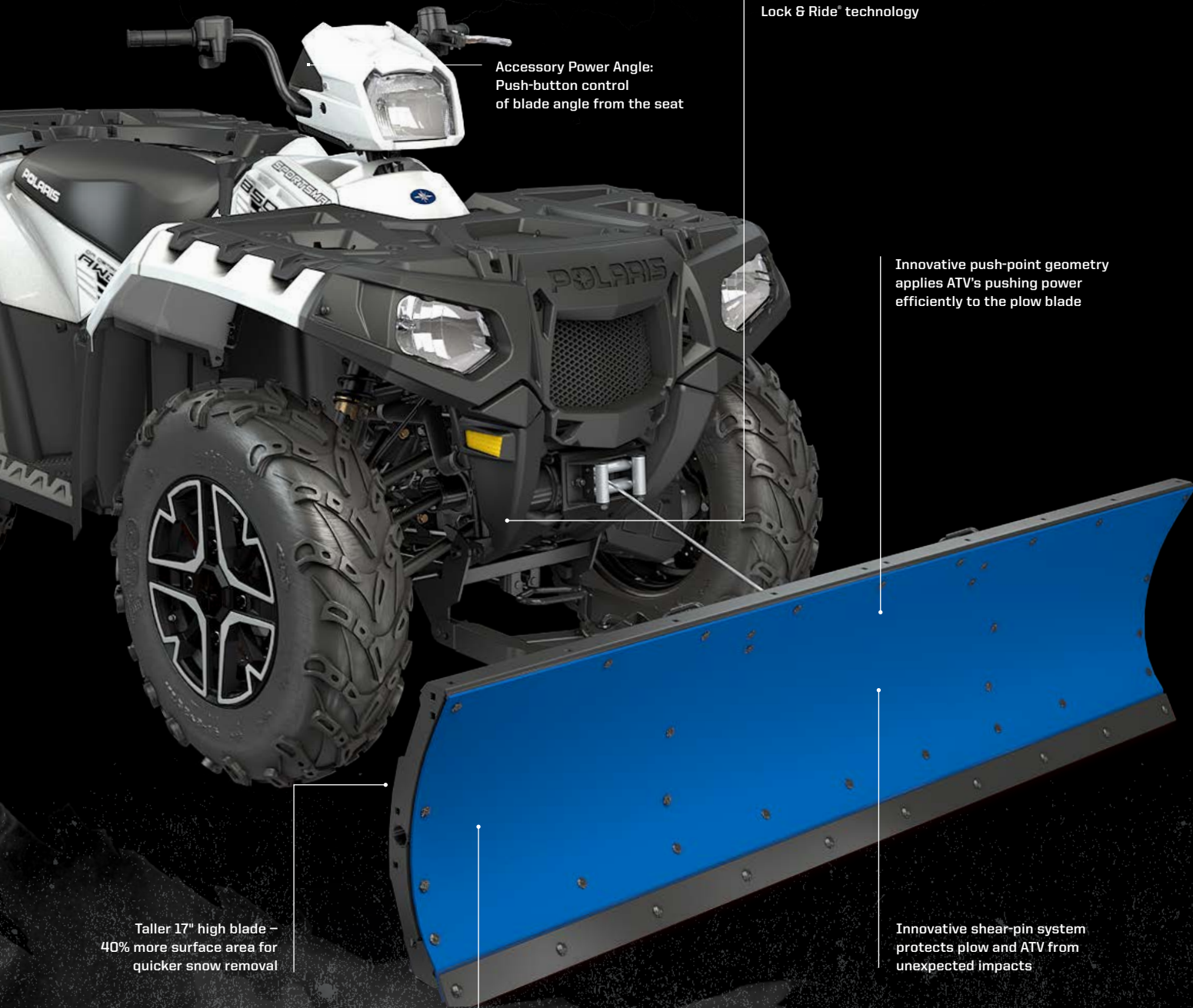

Plow installs in seconds with Polaris®-exclusive Lock & Ride® technology

Accessory Power Angle: Push-button control of blade angle from the seat

Innovative push-point geometry applies ATV's pushing power efficiently to the plow blade

Innovative shear-pin system protects plow and ATV from unexpected impacts

Taller 17" high blade - 40% more surface area for quicker snow removal

Choose from poly or steel blades, each one taller than ever to push more snow

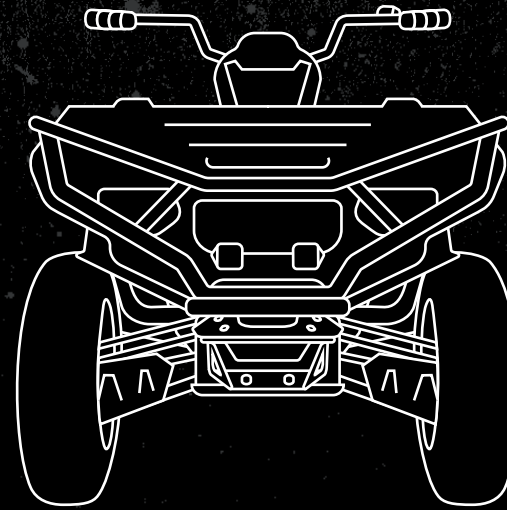

SEAMLESS FIT

DRIVE UP, CLIP IN AND GO - THE INTEGRATED POLARIS ENGINEERED™ GLACIER® PRO PLOWING SYSTEM SIMPLIFIES ADDING OR REMOVING YOUR PLOW

2016 Sportsman® models come with factory-installed mounts for your plow system, making installation and removal as simple as possible.

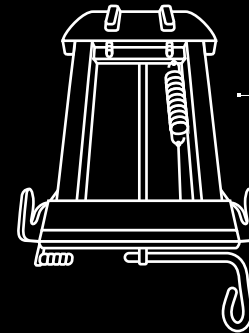

DRIVE-UP FRAME ATTACHMENT

The frame attachment ensures your plow system is at the right height for drive-up installation and removal.

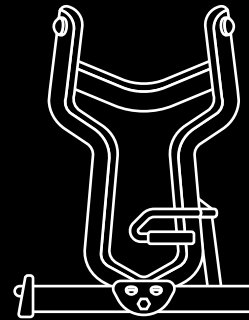

ROBUST FRAME

A plow system is only as strong as its frame, and Polaris Engineered™ plow frames are as durable as it gets. Made to push across a broader expanse of the plow blade, Glacier® PRO plow frames ensure more efficient plowing and enhanced plow system reliability.

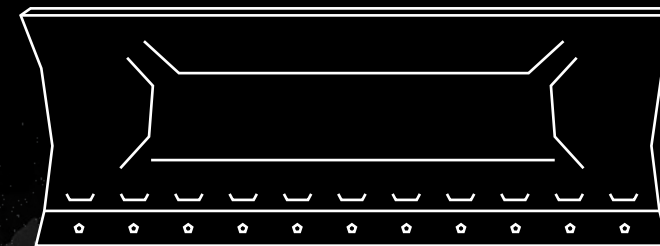

DURABLE BLADES

Available in strong stamped steel or corrosion-resistant poly materials, Polaris Engineered™ plow blades cover a large surface area for quick snow removal.

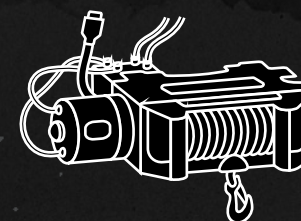

WINCH CONTROL

Leverage your plow by adding a Polaris Engineered™ winch. You not only get greater blade lift and control, but also total integration with your vehicle.

POLARIS®

ENGINEERED PARTS
ACCESSORIES & APPAREL

GLACIER® PRO PLOW SYSTEM



DEFINE YOUR GLACIER® PRO PLOW SYSTEM.

To complete your Polaris® plow system, you will need four components: a mount, a push frame, a lift method and blade. Use our selection guide to help you assemble your complete plow system.

STEP 1

SELECT A MOUNT INTEGRATED PLOW MOUNT FRAME ATTACHMENT

- Fits all model year 2015 and 2016 Sportsman® vehicles
- Fits all current Glacier® Pro Plow System components



» 2880437
SPORTSMAN® XP 850/1000 MY 15-16,
SPORTSMAN® TOURING 850/1000, MY 15-16,
SCRAMBLER® MY 15-16



» 2880436
SPORTSMAN® 570 MY 14-16, 570 SP MY 15-16,
SPORTSMAN® ETX MY 15-16

PLOW MOUNT FOR MY 14 AND OLDER VEHICLES

- Steel construction
- Mount attaches to ATV frame in designated locations
- Includes plow mount and mounting hardware

» 2879632
SPORTSMAN® XP 550/850 MY 09-14,
SPORTSMAN® TOURING MY 09-14,
SPORTSMAN® X2 550/850 MY 10-14,
SCRAMBLER® MY 13-14

» 2879633
SPORTSMAN® 400 MY 11-14, SPORTSMAN®
500/600/700/800 MY 05-RECENT,
SPORTSMAN® TOURING 500/800 MY 08-13,
SPORTSMAN® BIG BOSS® MY 09-13,
SPORTSMAN® X2 500/800 I19 MY 05-09,
SPORTSMAN® 570 MY 13-14, SPORTSMAN®
TOURING 570 MY 13-14,

STEP 2

SELECT A FRAME PLOW FRAME

- Material is steel
 - Installs on the plow blade of your choice (each sold separately)
 - Includes complete Glacier® PRO Plow Frame
- » 2879630
ALL GLACIER® PRO ATV PLOW MOUNTS AND
FRAME ATTACHMENTS

STEP 3

SELECT A LIFT METHOD

- CHOOSE A POLARIS® WINCH:**
- POLARIS® HD 3500 LB. WINCH
POLARIS® HD 2500 LB. WINCH
WARN® PROVANTAGE 3500 LB. WINCH
WARN® PROVANTAGE 2500 LB. WINCH
- See pages 10-11
- PLOW WINCH ROPE**
- Improved durability for plow use vs. steel cable
 - Thicker than standard synthetic rope
 - 8' (2.4m) of 0.25" (6mm) braided rope
- » 2878483
POLARIS® HD 2500 AND 3500 LB. WINCHES

STEP 4

SELECT A BLADE SELECT A PLOW BLADE THAT'S RIGHT FOR THE WAY YOU PLOW:

- GLACIER® PRO ATV PLOW
SYSTEMS 66" POLY BLADE**
- Material is polyethylene to prevent snow build up
 - Requires plow blade frame for mounting (sold separately)
 - Includes plow blade and metal wear bar
- » 2879637

- GLACIER® PRO ATV PLOW
SYSTEMS STEEL BLADE - 52"/60"**
- Blade material is steel
 - Requires plow blade frame for mounting (sold separately)
 - Includes plow blade and metal wear bar
- » 2879638 | 60"
» 2879639 | 52"

- GLACIER® PRO ATV PLOW
SYSTEMS PLOW ANGLE ADAPTOR
KIT, ATV**
- » 2879635

DOES YOUR SPORTSMAN® HAVE TRACKS?

GLACIER® PRO PLOW EXTENSION

- » 2879719
ALL GLACIER® PRO ATV PLOW MOUNTS
Plow Extension for use when using the Prospector Pro® Track System



PLOWS



STEP 5

SELECT ACCESSORIES - Push more snow with these optional accessories.



PLOW BLADE SNOW DEFLECTOR

- Helps confine snow, boosting plow capacity
 - Designed for easy on and off
- » 2879866 | 66"
» 2871808 | 60"



STANDARD WEAR BARS

- » 2879867
» 2871806
» 2877210

HEAVY-DUTY WEAR BAR

- » 2879868
» 2873426



COIL SPRING SPACER

- » 2872655



FRONT SPRING PRE-LOAD ADJUSTERS

- » 2876463



QUICK RELEASE SKID SHOES

- » 2205071

CURB FINDER (NOT SHOWN)

- » 2879872

SHEAR PIN REPLACEMENT (NOT SHOWN)

- » 2205063



PLOW MARKER

- Helps driver monitor plow blade position
 - Sold in pairs
- » 2872726



REAR TIRE CHAINS

- Size C, for 25" (63.5 cm) or 26" (66 cm) tires
- » 2881442

TRACKS



LOOK FORWARD TO THE NEXT BLIZZARD

It's tough to make the Sportsman® even more versatile than it already is. But with a set of tracks, you'll do just that. Tread through deep snow without concern.

STEP 1

SELECT A MOUNT

PROSPECTOR PRO® MOUNT

» 2879457
SPORTSMAN® 550/850/1000 MY 09-16, SPORTSMAN® TOURING 550/850/1000 MY 10-16, SPORTSMAN® X2, 550/850 MY 10-14, SCRAMBLER® 850/1000 MY 13-16

» 2879497
SPORTSMAN® 570 MY 14-16, SPORTSMAN® ETX MY 15-16, SPORTSMAN® 570 TOURING MY 14-16, SPORTSMAN® 570 X2 MY 15-16, SPORTSMAN® 500/600/700/800 MY 05-14

» 2880072
SPORTSMAN® X2 500/800 MY 08-14, SPORTSMAN® TOURING 500/800 MY 08-14

STEP 2

SELECT A KIT

PROSPECTOR PRO® TRACKS

• They deliver the best in performance, reliability, durability and value in every season

• Polaris® track systems deliver the utmost in performance and productivity, with absolutely no compromise of vehicle cargo capacity or pulling power

» 2879720
SCRAMBLER® 850 MY 13-15, SPORTSMAN® 550/850 (NON SP) MY 09-14, SPORTSMAN® 550/850 TOURING MY 09-14, SPORTSMAN® X2 550/850 MY 10-14, SPORTSMAN® XP 950 MY16 WITHOUT EPS

» 2881003
SPORTSMAN® 850 SP MY 15-16, SPORTSMAN® XP 1000 MY 15-16, SPORTSMAN® TOURING 850/1000, MY 15-16, SCRAMBLER® 1000 MY 15-16

» 2881025
SPORTSMAN® 570 SP, SPORTSMAN® 570 TOURING SP, SPORTSMAN® X2 570 EPS

» 2880020
SPORTSMAN® 570 MY 14-16 (NON SP), SPORTSMAN® ETX MY 15-16, SPORTSMAN® 570 TOURING MY 14-16 (NON SP), SPORTSMAN® 400/500/800 MY 05-14, SPORTSMAN® 500/800 TOURING MY 08-13, SPORTSMAN® X2 500/800 MY 08-13, SPORTSMAN® 850 NON EPS MY 15-16

BIG BOSS® 6X6 TRACK KIT

• Provides the ultimate in traction and flotation on snow
• Front tracks easily clear obstacles, steer easily
• Extended rear tracks deliver outstanding flotation
• Optimized gearing ensures full, true AWD performance.
• Includes mounts and tracks

» 2878421
BIG BOSS® 6X6
Does not fit Glacier® III or Glacier® II plows

GLACIER® PRO PLOW EXTENSION

» 2879719
ALL GLACIER® PRO ATV PLOW MOUNTS
Plow Extension for use when using the Prospector Pro® Track System



PROSPECTOR PRO TRACK SYSTEM

NEW track design provides:

- Improved durability in 4-season application
- Enhanced control when turning and side hilling

- Polaris®-specific gearing provides 1:1 ratio to:
- Minimize track slip, providing better climbing ability and improved traction in deep snow
 - Improve top speed by approximately 5%
 - Reduce operating RPM for a quieter ride



Flexible lug design for the highest level of deep snow performance by lifting up in deep snow as opposed to digging down

NEW Polaris®-exclusive composite frame to:

- Improve ride quality
- Reduce ice build-up
- Reduce weight

Polaris® exclusive optimized hub geometry that minimizes feedback and eases steering effort

Longer and wider footprint with front dual stabilizer for better stability.



Exclusive Polaris® 20-18 tooth gear ratio, optimized for Polaris® drivetrain



Heavy-duty, wide, rubberized wheels on a UHMW base to distribute the weight of the side-by-side

BUMPERS & GUARDS



ALL-TERRAIN PROTECTION

Protect your Sportsman® with our full-line of high-quality bumpers and guards. Premium protective accessories give you peace of mind out on the trail, allowing you to ride without reservations.



SPORTSMAN® XP BRUSHGUARDS

- Integrated styling designed to enhance the look of your Sportsman® XP
- Provide your Sportsman® XP with additional protection from trail hazards
- Material is steel
- Durable black wrinkle powder-coating for long-lasting, scratch-resistant finish
- Integrated mounting location for easy installation
- Front brushguard is integrated with mounting locations for accessory lighting

FRONT BRUSHGUARD

» 2878709
SPORTSMAN® XP 550/850 MY 09-16, SPORTSMAN® TOURING 550/850 MY 10-16,
SPORTSMAN® X2 550/850, SPORTSMAN® XP 1000 MY 15-16, SPORTSMAN® XP 1000 TOURING MY 15-16

REAR BRUSHGUARD

» 2878710
SPORTSMAN® XP 550/850 MY 09-16, SPORTSMAN® XP 1000 MY 15-16



SPORTSMAN® 570 / 450 H.O. BRUSHGUARD

- Distinctive off-road styling helps customize for Sportsman® 570
- Provide your Sportsman® 570 with additional protection from trail hazards
- Material is steel
- Durable black powder-coating for long-lasting, scratch-resistant finish
- Integrated mounting location for easy installation
- Front brushguard is integrated with mounting locations for accessory lighting

FRONT BRUSHGUARD

» 2879714
SPORTSMAN® 570 MY 14-16, SPORTSMAN® 570 TOURING MY 14-16, SPORTSMAN® ETX MY 15,
SPORTSMAN® 450 HO MY 16

REAR BRUSHGUARD

» 2879715
SPORTSMAN® 570 MY 14-16, SPORTSMAN® 570 TOURING MY 14-15, SPORTSMAN® ETX MY 15,
SPORTSMAN® 450 HO MY 16



BODY GUARD

- Provides outstanding protection for front and rear fenders
- Strong and durable 16-gauge, 1.5" (3.8 cm) tube construction

» 2878341
SPORTSMAN® XP 550/850 MY 09-16, SPORTSMAN® XP 1000 MY 15-16
Does not fit with Sportsman® XP Fender Flare Kit 2878687



SPORTSMAN® TOURING REAR BRUSHGUARD

- Designed specifically for the Sportsman® Touring
- Adds heavy-duty rear protection and a custom look

» 2878324
SPORTSMAN® TOURING 550/850 MY 10-16, SPORTSMAN® XP 1000 MY 15-16,
SPORTSMAN® XP TOURING 1000 MY 15-16

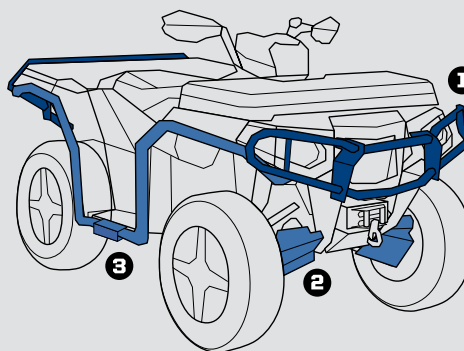

1
FRONT & REAR BRUSHGUARDS
Protection essentials. Shield the front from direct impacts while riding, and cover the back from reversing into objects or accidental rear-endings.

2
A-ARM GUARDS
Shield your shafts, A-arms and suspension from low-lying threats such as roots, large rocks and dramatic shifts in elevation.

3
BODY GUARD
Side and fender protection from clipping tree trunks or slipping into hard objects in sloppy terrain.

BUMPERS & GUARDS CONTINUED



SPORTSMAN® XP A-ARM GUARDS

- Lightweight, durable guards provide reliable A-Arm protection
- HMW polyethylene construction delivers strength and low coefficient of friction so guards slide freely over rocks
- Molded construction and ribbing for optimized strength and rigidity
- Guards absorb impacts and retain their shape rather than bending as metal guards can
- Engineered with integrated drain channels to evacuate water and mud
- Easy to install in place of stock guards

FRONT A-ARM GUARDS

» 2880644
SPORTSMAN® 550/850 MY 10-15, SPORTSMAN® XP 1000

REAR A-ARM GUARDS

» 2880678
SPORTSMAN® 550/850 MY 10-15, SPORTSMAN® XP 1000

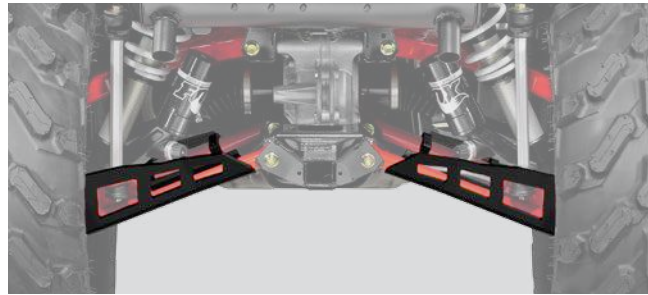

SPORTSMAN® 570 / 450 H.O. A-ARM GUARDS

- Lightweight, durable guards provide reliable A-Arm protection
- HMW polyethylene construction delivers strength and low coefficient of friction so guards slide freely over rocks
- Molded construction and ribbing for optimized strength and rigidity
- Guards absorb impacts and retain their shape rather than bending as metal guards can
- Engineered with integrated drain channels to evacuate water and mud
- Easy to install in place of stock guards

FRONT A-ARM GUARDS

» 2879889
SPORTSMAN® 570 MY 14-16, SPORTSMAN® 570 TOURING, SPORTSMAN® ETX MY 15, SPORTSMAN® 450 MY 16, SPORTSMAN® 570 X2 MY 15-16

REAR A-ARM GUARDS

» 2880679
SPORTSMAN® 570 MY 14-16, SPORTSMAN® 570 TOURING, SPORTSMAN® ETX MY 15, SPORTSMAN® 450 MY 16, SPORTSMAN® 570 X2 MY 15-16



FENDER FLARE KIT

- Provides an additional 3" of coverage for extra protection from mud and water
- Ideal for ATVs running accessory wheels with wider offsets
- Provides a custom look to your Sportsman® XP

» 2878687
SPORTSMAN® XP 550/850 MY 09-16,
SPORTSMAN® XP 1000 MY 15-16



HANDGUARDS

- Offer superior hand protection while enhancing vehicle style

» 2876883 | WHITE
» 2876846 | BLACK
» 2876845 | RED

FITS ALL SPORTSMAN® MODEL WITH (2879380) HAND GUARD MOUNT INSTALLED

Requires Handguard Mount (2879380)



HANDGUARD MOUNT

- This handguard mount is required when installing Polaris® Handguards.

» 2879380
FITS ALL POLARIS® ATV MODELS



FRONT BRUSHGUARD

- Distinctive off-road styling for customization
- Provides additional protection from trail hazards
- Durable black wrinkle powder-coating for long-lasting, scratch-resistant finish
- Front brushguards have integrated mounting locations for accessory lighting
- Integrated mounting locations for easy installation
- Compatible with all Polaris® plow systems and winches

» 2878669
SPORTSMAN® 400/500/800 MY 11-14, SPORTSMAN® TOURING 500/800 MY 11-14, SPORTSMAN® BIG BOSS® MY 11-14



REAR BRUSHGUARD

- A great addition in both form and function
- Tough 2" (5.1 cm) diameter tubing

» 2878046
SPORTSMAN® 500/600/700/800 MY 05-14, SPORTSMAN® 400 MY 11-14



DELUXE FRONT BRUSHGUARD

- Distinctive off-road styling for customization
- Provides additional protection from trail hazards
- Integrates with any winch or plow system

» 2876102-418
SPORTSMAN® 500/600/700/800 MY 05-10, SPORTSMAN® X2 500/800 MY 05-10, SPORTSMAN® TOURING 500/800 MY 05-10, SPORTSMAN® 6X6 MY 09-10



DELUXE REAR BRUSHGUARD

- Provide your Sportsman® with additional protection from trail hazards
- Distinctive off-road styling helps you customize your ride
- Durable black wrinkle powder-coating for long-lasting, scratch-resistant finish
- Integrated mounting locations for easy installation

» 2878670
SPORTSMAN® 400/500/800 MY 11-14



SPORTSMAN® XP EXTREME REAR BRUSHGUARD

- Distinctive off-road styling for customization
- Provides additional protection from trail hazards
- Durable black wrinkle powder-coating for long-lasting, scratch-resistant finish
- Integrated mounting locations for easy installation

» 2876607
SPORTSMAN® XP 550/850 MY 09-13



SPORTSMAN® X2® REAR BUMPER

- Distinctive off-road styling for customization
- Provides additional protection from trail hazards
- Designed specifically for the Sportsman X2®

» 2877686
SPORTSMAN® 500, 800 X2 MY 06-14

TIRES & WHEELS



PRO ARMOR

For over a decade, Pro Armor® has been recognized as an industry leader in premium off-road accessories. Polaris® has partnered with Pro Armor® to produce a line of tires specially made for Polaris® vehicles. All featured tires are designed for a seamless fit and finish.

FULL TREAD. FULL STYLE.

No component is as important as a quality set of tires and wheels. Our completely new selection of off-road specialist Pro Armor® tires and rugged, stylish wheels deliver the performance and durability you demand wherever you're riding.

BUILD YOUR SET BY SELECTING THE BEST TIRE AND WHEELS FOR WHERE YOU RIDE.



STEP 1

SELECT YOUR TIRES

Choose the tread that best suits your particular riding conditions.

STEP 2

SELECT YOUR WHEELS

Add some style to your ride with a set of tough, attention-stealing wheels.

STEP 3

SELECT YOUR LUG NUTS

Lug nuts not included with wheels or tires.

STEP 4

SELECT YOUR RINGS

Protect your bead lock rings while adding some flair to your wheels.

STEP 5

FINALIZE YOUR SET

Using your tire and wheel selection, select your set and order by visiting your local dealer or learn more by going to Polaris.com.

STEP 1 SELECT YOUR TIRES



- Tread patterns optimized for extreme traction
- Side walls tested for supreme durability
- Ideal for both hard pack and loose trail



- Industry leading anti-puncture side walls
- Aggressive long lasting tread



- Provides traction and durability
- Built to perform in sand, jagged rocks or any other extreme terrain



- Extra deep treads
- Full wall side bite



- Provides traction and durability
- Built to perform in sand, jagged rocks or any other extreme terrain



- Handles extreme cold
- Holds shape and provide traction



- Flexible "grippy" tread
- Aggressive side bite



PRO ARMOR® ATTACK TIRE

- Unique full-face tread design provides all season traction in any terrain
- Harder durometer lugs promotes extended wear tire life
- Durable 8-ply sidewall resists punctures and leaks
- Also available as a complete wheel and tire combination package

» FRONT | 5415613 | 26" x 9" x 14"
» REAR | 5415614 | 26" x 11" x 14"

ALL RANGER®, RZR®, SPORTSMAN® AND ACE® MODELS



PRO ARMOR® HAMMER TIRE

- Block pattern tread design delivers ideal varied trail and desert traction
- High durometer lug pattern withstands heat, abuse and promotes long tire life
- Large 30-inch design for high-performance applications
- Durable 8-ply sidewall resists punctures and leaks
- Also available as a complete wheel and tire combination package

» FRONT | 5415615 | 30" x 9.5" x 15"
» REAR | 5415615 | 30" x 9.5" x 15"

RZR® XP 1000 MODELS, RZR® XP TURBO



PRO ARMOR® CRAWLER XG TIRE

- Combination square block profile and soft durometer tread design
- Ideal for rock crawling and general trail and desert conditions
- Large 30-inch design for high-performance applications
- Durable 8-ply sidewall resists punctures and leaks
- Also available as a complete wheel and tire combination package

» FRONT | 5415616 | 30" x 10" x 14"
» REAR | 5415616 | 30" x 10" x 14"

RZR® XP 1000 MODELS, RZR® XP TURBO



PRO ARMOR® CRAWLER XR TIRE

- Combination square block profile and soft durometer tread design
- Ideal for rock crawling and general trail and desert conditions
- Compact 28-inch design fits many of today's stock vehicle applications
- Durable 8-ply sidewall resists punctures and leaks
- Also available as a complete wheel and tire combination package

» FRONT | 5415536 | 28" x 10" x 14"
» REAR | 5415536 | 28" x 10" x 14"

ALL RZR® MODELS



PRO ARMOR® DAGGER TIRE

- Multi-performance tire for both mud and loose trail conditions.
- Deep, self-cleaning lug and wide tire design for exceptional mud pit performance
- Rounded profile and "fuller" lug pattern for comfortable on-trail attributes
- Durable 8-ply sidewall resists punctures and leaks
- Also available as a complete wheel and tire combination package

» FRONT | 5415617 | 27" x 9" x 14"
» REAR | 5415617 | 27" x 9" x 14"

ALL RANGER®, RZR®, SPORTSMAN® MODELS



PRO ARMOR® ANARCHY TIRE

- Ultra deep lugs provide maximum traction in the worst mud conditions
- Self-cleaning grooves help maintain maximum traction
- Deep sidewall tread delivers added bite in off-camber conditions
- Wide tire design prevents loss of traction in rutted terrain
- Durable 8-ply sidewall resists punctures and leaks

» FRONT | 5415535 | 29.5" x 9" x 14"
» REAR | 5415535 | 29.5" x 9" x 14"

RANGER XP® 900 HIGH LIFTER EDITION, SPORTSMAN® 850/XP 1000 HIGH LIFTER EDITION, RZR® XP 1000 MODELS AND RZR® XP TURBO



PRO ARMOR® SAND TIRE

- Precision engineered 14-paddle REAR tires offer the ultimate in sand acceleration
- Unique 3-tiered FRONT tire design delivers hard turning bite and straight-line tracking
- Lightweight with flexible sidewalls creates added flotation and stability
- Developed to handle extreme horsepower and high-performance riding
- Also available as a complete wheel and tire combination package

» FRONT | 5415251 | 30" x 11" x 14"
» REAR | 5415252 | 30" x 13" x 14"

RZR® XP 1000 MODELS AND RZR® XP TURBO Available in September 2015



PRO ARMOR® DUNE TIRE

- Affordable sand specific tire ideal for first time dune riders or as a secondary set
- Three-tiered FRONT tire serves up predictable cornering in loose sand
- Lightweight 12-paddle REAR tires tout a flexible sidewall for flotation and acceleration
- Also available as a complete wheel and tire combination package

» FRONT | 5415533 | 28" x 9" x 14"
» REAR | 5415534 | 28" x 11" x 14"

ALL RZR® MODELS

Available in September 2015



PRO ARMOR® XD-K TIRE

- Triple belted, Kevlar sidewall ensures extreme puncture resistance
- Rugged 8-ply tire face construction
- Aggressive 1.25" lugs
- REAR tires load rated at 1330lbs; FRONT tires load rated at 1000lbs

» FRONT | 5415756 | 26" x 9" x 12"
» REAR | 5415757 | 26" x 11" x 12"

ALL RANGER®, RZR®, SPORTSMAN® AND ACE® MODELS

Polaris® stock 12" wheels



TERRAINARMOR® NON-PNEUMATIC TIRES

Never get a flat with revolutionary TerrainArmor™ tire technology, the industry's first Non-Pneumatic tire built to sustain damage without compromising functionality or mobility. This polymeric web design can withstand harsh terrain.

» 2880818 | 8" TerrainArmor™ Tire Kit | includes 4 8" tires & speed key kit
RANGER XP® 900 FULL-SIZE MY 13-16, CREW XP 900 MY 14-16, XP 570 MY 15-16, CREW 570 FULL-SIZE MY 15-16

Ball joint upgrade kit (PN 2880928) required for XP 900 MY13-14, CREW XP 900 MY13-14

*Warranty in accordance with Polaris' recommended usage, including designated payload capacities and limiting speed to 25 mph with speed key kit



1 Year Limited Warranty

TIRES & WHEELS CONTINUED

STEP 2 SELECT YOUR WHEELS



LYTE 14" WHEEL

- » FRONT | 14" x 8"
- ACCENT | 1522548-266
- BLACK | 1522548-458
- » REAR | 14" x 10"
- ACCENT | 1522549-266
- BLACK | 1522549-458

RZR® XP 1000

Only fits with Sand and Dune tires



HEXLR 15" WHEEL

- » FRONT/ REAR | 15" x 7"
- TITANIUM | 1522173-654
- BLACK | 1522173-458

RZR® XP 1000

Only fits with Hammer tire
Requires Billet Rings (See Step 4)



REBLR 14" WHEEL

- » FRONT | 14" x 7" | 1522238-458
- » REAR | 14" x 8" | 1522239-458

ALL RANGER®, RZR®, SPORTSMAN® AND ACE® MODELS

Requires Billet Rings (See Step 4)



THRASHER 14" WHEEL

- » FRONT | 14" x 6"
- LUSTER | 1522241-410
- BLACK | 1522241-458
- » REAR | 14" x 8"
- LUSTER | 1522242-410
- BLACK | 1522242-458

SPORTSMAN® 850 AND SPORTSMAN® XP 1000 MODELS



WYDE 15" WHEEL

- » FRONT/ REAR | 15" x 7"
- ACCENT | 1522550-266
- » FRONT/ REAR | 15" x 7"
- BLACK | 1522550-458

RZR® XP 1000 MODELS

*Only fits Hammer tire



SHACKLE 14" WHEEL

- » FRONT | 14" x 7"
- ACCENT | 1522546-266
- BLACK | 1522546-458
- » REAR | 14" x 8"
- ACCENT | 1522547-266
- BLACK | 1522547-458

ALL RANGER®, RZR®, SPORTSMAN® AND ACE® MODELS



BUCKLE 14" WHEEL

- » FRONT | 14" x 7"
- ACCENT | 1522544-266
- BLACK | 1522544-458
- » REAR | 14" x 8"
- ACCENT | 1522545-266
- BLACK | 1522545-458

ALL RANGER®, RZR®, SPORTSMAN® AND ACE® MODELS



SPLIT 14" WHEEL

- » FRONT | 14" x 6" | 1522542-458
- » REAR | 14" x 8" | 1522543-458

RANGER®, RZR®, SPORTSMAN® AND ACE® MODELS



SIXR 14" WHEEL

- » FRONT 14" x 7"
- LUSTER | 1521507-410
- BLACK | 1521507-521
- MACHINED | 1521507-266
- » REAR 14" x 8"
- LUSTER | 1521508-410
- BLACK | 1521508-521
- MACHINED | 1521507-266

ALL RANGER®, RZR®, SPORTSMAN® AND ACE® MODELS



1522243

1521509



1522675-458

REPLACEMENT CENTER CAPS

- » 1522243-437 | LUSTER
- » 1522243-458 | FLAT BLACK
- ONLY FITS THRASHER AND HEXLR

- » 1521509-410 | LUSTER
- » 1521509-521 | FLAT BLACK
- FITS ALL WHEELS EXCEPT THRASHER, HEXLR AND WYDE
- Requires 14" Forge Billet Rings
- 1522244-133, 1522244-293 or 1522244-589

- » 1522675-458 | FLAT BLACK
- ONLY FIT WYDE® WHEELS

STEP 3 SELECT YOUR LUG NUTS



12 MM LUG NUT KITS

- » 2877385 | SET OF 16 | WITH WRENCH
- » 2877384 | SET OF 4 | NO WRENCH
- » 2204966 | 12 mm LUG NUT WRENCH

SPORTSMAN® 1000, 850 AND ALL SCRAMBLER MODELS

SAE® LUG NUTS FOR ALUMINUM WHEELS

- » 2876754 | SET OF 4
- » 2877409 | SET OF 16

SPORTSMAN® 570 AND EXT MODELS

STEP 4 SELECT YOUR RINGS



FORGE BILLET RINGS

• Add high-performance custom style along with reinforced tire mounting security with a set of these Machined Beadlock Rings.

- » VOODOO BLUE | 14" | 1522244-619
- » MACHINED | 14" | 1522244-266
- » WHITE | 14" | 1522244-133
- » INDY RED | 14" | 1522244-293
- » ORANGE CRUSH | 14" | 1522244-589
- » VOODOO BLUE | 15" | 1522240-619
- » MACHINED | 15" | 1522240-266
- » WHITE | 15" | 1522240-133
- » INDY RED | 15" | 1522240-293
- » ORANGE CRUSH | 15" | 1522240-589

14" OR 15" BEADLOCK WHEELS
Sold individually

STEP 5 FINALIZE YOUR SET (4 WHEELS PER SET)

TIRES

Using your tire and wheel selection, select your set and order by visiting your local Polaris® dealer or learn more at Polaris.com.

PRO ARMOR® ATTACK 14" FRONT: 5415613 REAR: 5415614	PRO ARMOR® HAMMER 15" FRONT: 5415615 REAR: 5415615	PRO ARMOR® CRAWLER XG 30" FRONT: 5415616 REAR: 5415616	PRO ARMOR® CRAWLER XR 28" FRONT: 5415536 REAR: 5415536	PRO ARMOR® DAGGER 14" FRONT: 5415617 REAR: 5415617	PRO ARMOR® ANARCHY 14" FRONT: 5415535 REAR: 5415535	PRO ARMOR® SAND 14" FRONT: 5415251 REAR: 5415252 Available September 2015	PRO ARMOR® DUNE 14" FRONT: 5415533 REAR: 5415534 Available September 2015

WHEELS

	BUCKLE 14" - ACCENT FRONT: 152244-266 REAR: 1522545-266	2881335	-	2881560	2881343	2881337	2881341	2881339	2881345
	BUCKLE 14" - BLACK FRONT: 1522544-458 REAR: 1522545-458	2881336	-	2881561	2881344	2881338	2881342	2881340	2881346
	SHACKLE 14" - ACCENT FRONT: 1522546-266 REAR: 1522547-266	2881347	-	2881558	2881355	2881349	2881353	2881351	2881357
	SHACKLE 14" - BLACK FRONT: 1522546-458 REAR: 1522547-458	2881348	-	2881559	2881356	2881350	2881354	2881352	2881358
	SIXR 14" - LUSTER FRONT: 1521507-410 REAR: 1521508-410	2881359	-	2881564	2881371	2881362	2881368	2881365	2881374
	SIXR 14" - BLACK FRONT: 1521507-521 REAR: 1521508-521	2881360	-	2881563	2881372	2881363	2881369	2881366	2881375
	SIXR 14" - MACHINED FRONT: 1521507-266 REAR: 1521508-266	2881361	-	2881562	2881373	2881364	2881370	2881367	2881376
	THRASHER 14" - LUSTER FRONT: 1522241-410 REAR: 1522242-410 Sportsman® XP 1000 only	2881377	-	-	-	2881379	2881445	-	-
	THRASHER 14" - FLAT BLACK FRONT: 1522241-458 REAR: 1522242-458 Sportsman® XP 1000 only	2881378	-	-	-	2881380	2881446	-	-
	REBLR 14" - FLAT BLACK FRONT: 1522238-458 REAR: 1522239-458 Requires Billet Rings (See Step 4)	2881381	-	2881382	2881386	2881383	2881385	2881384	2881387
	HEXLR 15" - BLACK FRONT: 1522173-458 REAR: 1522173-458 Requires Billet Rings (See Step 4)	-	2881388	-	-	-	-	-	-
	HEXLR 15" - TITANIUM FRONT: 1522173-654 REAR: 1522173-654 Requires Billet Rings (See Step 4)	-	2881389	-	-	-	-	-	-
	LYTE 14" - ACCENT FRONT: 1522548-266 REAR: 1522549-266	-	-	-	-	-	-	2881394	2881400
	LYTE 14" - BLACK FRONT: 1522548-458 REAR: 1522549-458	-	-	-	-	-	-	2881395	2881401
	WYDE 15" - ACCENT FRONT: 1522550-266 REAR: 1522550-266	-	2881402	-	-	-	-	-	-
	WYDE 15" - BLACK FRONT: 1522550-458 REAR: 1522550-458	-	2881403	-	-	-	-	-	-
	SPLIT 14" - BLACK FRONT: 1522542-458 REAR: 1522543-458	2881404	-	-	-	2881405	-	2881406	2881407

WINDSHIELDS



THE CHOICE IS CLEAR

Upgrade your riding experience with one of Polaris' high quality windshields. In addition to wind protection, a windshield will deflect flying debris and branches without sacrificing visibility.



Tall 19.25" (48.9 cm)
Polaris Pursuit® Camo

LOCK & RIDE

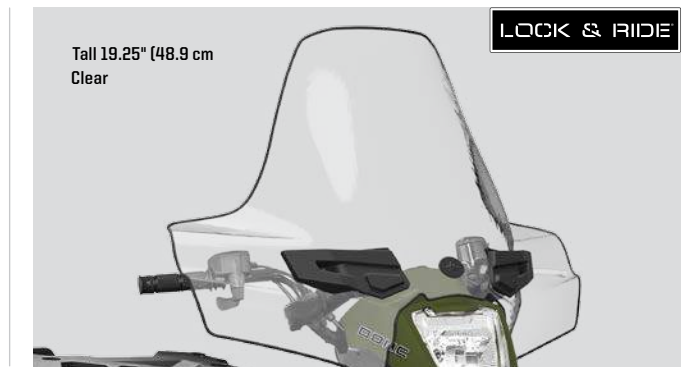

Tall 19.25" (48.9 cm)
Clear

LOCK & RIDE



Mid 15.5" (39.4 cm)
Black

LOCK & RIDE

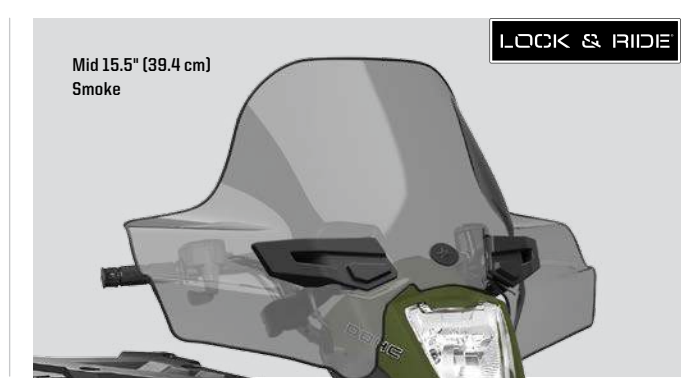

Mid 15.5" (39.4 cm)
Smoke

LOCK & RIDE



Low 9.5" (24.1 cm) Black

LOCK & RIDE

LOCK & RIDE® SPORTSMAN® WINDSHIELDS

- Windshield can be installed on the ATV in seconds & removed just as easily
- Lock & Ride® mounts let a rider adjust the height & angle of the windshield
- Windshield provides reliable protection against wind, inclement weather & off-road hazards
- Black finish enhances the ATV's sporty style
- Polaris® branded

- » 2880539-587 | Tall 19.25" (48.9 cm) Polaris Pursuit® Camo
- » 2880539-409 | Tall 19.25" (48.9 cm) Clear
- » 2880540-070 | Mid 15.5" (39.4 cm) Black
- » 2880540-412 | Mid 15.5" (39.4 cm) Smoke
- » 2880541-070 | Low 9.5" (24.1 cm) Black

SPORTSMAN® 570 SP MY 15-16, SPORTSMAN® XP 850/1000 MY 15-16
* Does not fit Sportsman® Highlifter editions

- » 2878389-587 | Tall 19.25" (48.9 cm) Polaris Pursuit® Camo
- » 2878389 | Tall 19.25" (48.9 cm) Clear
- » 2878388-070 | Mid 15.5" (39.4 cm) Black
- » 2878388 | Mid 15.5" (39.4 cm) Smoke
- » 2878387 | Low 9.5" (24.1 cm) Black

SPORTSMAN® 400/500/800 MY 05-15, SPORTSMAN® 6X6 MY 09-16, SPORTSMAN® X2 MY 10-16, SPORTSMAN® TOURING 500/800 MY 08-15, SPORTSMAN® 570 MY 14-16, SPORTSMAN® 570 TOURING MY 14-16
Does not fit Sportsman® 570 SP

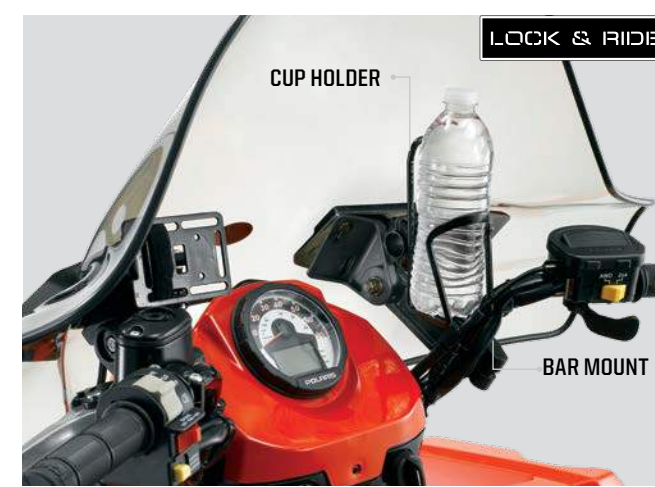

LOCK & RIDE

LOCK & RIDE® ACCESSORY BAR MOUNT

- Attaches to the windshield and has a 1" (2.4 cm) tube for a near-endless array of accessory mounting options

» 2878403
ALL SPORTSMAN® MODELS

CUP HOLDER

- Conveniently holds a cup, can or thermal mug on the inside of the windshield
- Requires Lock & Ride® Accessory Bar Mount (2878403 sold separately)

» 2878402
ALL SPORTSMAN® MODELS

RACKS

CARRY YOUR WEIGHT

Equip your Sportsman® to haul all of your gear with Polaris' line up of premium quality racks. Rugged construction and ample tie-down points provide solutions to nearly all of your storage concerns.

SPORTSMAN® XP® RACK EXTENDERS

- Durable, black wrinkle powder-coated finish
- 4.5" (11.4 cm) tall to provide additional cargo hauling support
- Tough, rugged tubular steel construction
- Multiple integrated tie-down points to secure cargo
- Integrates with Polaris® Lock & Ride® Cargo Boxes and Gun Boots



FRONT



REAR

FRONT RACK EXTENDER

» 2879890
SPORTSMAN® XP 550/850/1000 MY 09-16, SPORTSMAN® TOURING 550/850/1000 MY 09-16, SPORTSMAN® X2 550/850 MY 10-16
Does not fit vehicles with Front Cargo Box (2877951)

REAR RACK EXTENDER

» 2879891
SPORTSMAN® XP 550/850/1000 MY 09-16

SPORTSMAN® XP® COMPOSITE RACK EXTENDERS

- 4.5" (11.4 cm) tall to provide additional cargo hauling support
- Tough, rugged, glass-filled nylon construction
- Multiple integrated tie-down points to secure cargo
- Integrate with Polaris® Lock & Ride® Rear Cargo Boxes and Gun Boots



FRONT



REAR

FRONT RACK EXTENDER

» 2876598
SPORTSMAN® XP 550/850 MY 09-16, SPORTSMAN® X2 550/850 MY 10-14

REAR RACK EXTENDER

» 2876599
SPORTSMAN® XP 550/850/1000 MY 09-16

SPORTSMAN® 570 / 450 H.O. RACK EXTENDERS

- Steel construction
- Attach in designated, integrated mounting locations on the Sportsman® 570 front/back cargo rack
- Includes ATV Front Rack Extender and mounting hardware
- Durable, flat black powder-coated finish



FRONT



REAR

FRONT RACK EXTENDER

» 2879716
SPORTSMAN® 570 MY 14-16, SPORTSMAN® 570 TOURING MY 14-16, SPORTSMAN® ETX MY 15, SPORTSMAN® 450 HO MY 16

REAR RACK EXTENDER

» 2879717
SPORTSMAN® 570 MY 14-16, SPORTSMAN® 570 TOURING MY 14-16, SPORTSMAN® ETX MY 15, SPORTSMAN® 450 HO MY 16

SPORTSMAN® RACK EXTENDERS

- Perfect for securing gear bags while you ride
- Made of powder-coated steel, 4.5" (11.4 cm) tall
- Work with Sportsman® Cargo Box and Gun Boot Mount



FRONT



REAR

FRONT RACK EXTENDER

» 2878044
SPORTSMAN® MY 05-10

REAR RACK EXTENDER

» 2878045
SPORTSMAN® MY 05-10

SPORTSMAN® RACK EXTENDERS

- Strong tubular construction provides rigid protection and a secure place to attach tie-down straps or cargo nets
- Install easily onto the front cargo rack
- Black finish coordinates with cargo rack and overall styling of the Sportsman® for an integrated look
- Work with Sportsman® Cargo Box and Gun Boot Mount



FRONT



REAR

RACK EXTENDER

» 2878671 | FRONT
SPORTSMAN® 400/500/800 MY 11-14, SPORTSMAN® BIG BOSS® MY 11-14, SPORTSMAN® TOURING 500 MY 11-14

REAR RACK EXTENDER

» 2878672 | REAR
SPORTSMAN® 500/800 MY 11-14, SPORTSMAN® 400 (EXCEPT S.E.) MY 11-14

TOURING RACK EXTENDER

- Designed specifically for the Sportsman® Touring
- Adds extra tie-down points for cargo
- Works with Gun Boot Mount

» 2876486-418
SPORTSMAN® TOURING 500/800 MY 08-14
» 2878385
SPORTSMAN® TOURING 850/1000 MY 15, SPORTSMAN® TOURING 550/850 MY 10-14



CRANK IT UP WITH FRONT & REAR AUDIO MOUNTING BARS (PG. 39)

STORAGE



HAUL IT ALL

Carry more with Lock & Ride® storage for your Sportsman®. Whether it's tools, hunting gear or anything else, there's an all-new, quick-installing Lock & Ride® solution that will keep your gear safe and at the ready when you need it.

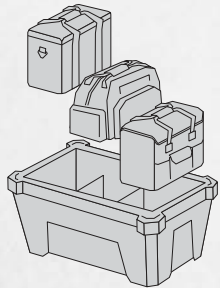

LOCK & RIDE® XL STORAGE BOX / NEW

- Extra large storage capacity box with lid secured by four rubber clasps
- Designed to mount to several Polaris® RANGER®, Sportsman® and RZR® 900 vehicles
- Includes internal dividers and reversible lid for additional tie-down points
- Use with internal storage bags to organize your gear
- Requires vehicle specific mounting kit
- Dimensions: 37"x16"x21"

» 2881128-070
ALL SPORTSMAN XP 1000/850, SPORTSMAN 570 SP, SPORTSMAN 570, SPORTSMAN ETX, AND MY11-14 SPORTSMAN 400/500 MODELS



LOCK & RIDE® XL STORAGE BOX MOUNT / NEW

- Mount storage box directly to rear Sportsman® rack
- Unique metal teeth align directly with cut-outs on bottom of storage box to ensure secure fit
- Tie-down straps are included for added cargo security

» 2881331
ALL SPORTSMAN® MODELS



XL SOFT SIDE COOLER / NEW

- Designed to fit inside the Lock & Ride® XL Storage Box (2881128-070)
- Held securely in place by internal Lock & Ride® XL Storage Box one-third divider
- Durable 600 Denier PVC shell and insulated lining keeps items cool and protected
- Shoulder strap and convenient zipper top allows for standalone use

» 2881428



XL TRAIL BAG / NEW

- Delivers convenient and easily accessible storage solutions
- High-strength 600 Denier PVC outer shell features multiple zipper access options
- Designed to fit inside the Lock & Ride® XL Storage Box (2881128-070) or standalone
- Held securely in place by internal Lock & Ride® XL Storage Box one-third divider

» 2881130



XL TOOL BAG / NEW

- Semi-rigid design provides strength and shape for larger items
- Large zipper access and multiple pocket storage in one bag
- Designed to fit inside the Lock & Ride® XL Storage Box (2881128-070) or standalone
- Held securely in place by internal Lock & Ride® XL Storage Box one-third divider

» 2881129

LOCK & RIDE

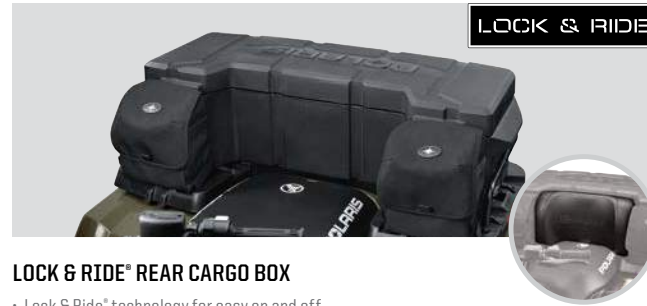

LOCK & RIDE® REAR CARGO BOX

- Lock & Ride® technology for easy on and off
- Large capacity, with locking latches and lid gaskets
- Molded handles for easy transport
- Works with Rack Extender, Gun Boot, Cargo Pocket Bags

» 2875176
SPORTSMAN® 500/600/700/800 MY 05-14, SPORTSMAN® 400 MY 05 AND 11-14, SPORTSMAN® 570 MY 14-16

LOCK & RIDE® REAR CARGO BOX BACKREST

- Provides extra back support and comfort on your Sportsman®
- Attaches to Lock & Ride® Rear Cargo Box

» 2876367
FITS SPORTSMAN® LOCK & RIDE® REAR CARGO BOX (2875176)
Intended for operator use only

LOCK & RIDE



LOCK & RIDE® REAR CARGO BOX

- Lock & Ride® system for easy on/off
- Fits in either side of rear box
- Heavy-duty double-wall lid with molded hinges for easy open/close
- Sold individually

» 2877921
SPORTSMAN® X2 MY 07-14

LOCK & RIDE



LOCK & RIDE® FRONT CARGO BOX

- Lock & Ride®: Installs or removes quickly and easily
- Keeps your gear dry, secure and protected
- Replaces stock rack, adds convenient storage location
- Durable injection-molded construction
- Styled to match the Sportsman® XP

» 2877951
SPORTSMAN® XP 550/850/1000 MY 09-16, SPORTSMAN® X2 550/850/1000 MY 10-16
Does not fit with Front Rack Extender (2879890)



FRONT CARGO BAG

- Provides convenient storage for small tools and gear
- Heavy-duty polyester construction
- Includes handle for easy transport

» 2876602
SPORTSMAN® 550/850/1000 MY 09-16, SPORTSMAN® X2 550/850 MY 10-14



POD BAG

- Provides easy access to items
- Features a convenient map pouch for easy viewing

» 2876605
SPORTSMAN® XP 550/850/1000 MY 09-16, SPORTSMAN® TOURING 550/850/1000 MY 10-16, SPORTSMAN® X2 550/850 MY 10-14



FRONT POUCH BAG

- Fits under Sportsman® XP front rack
- Stores tools and spare plugs
- Water-resistant fabric and zippers

» 2876615
SPORTSMAN® XP 550/850/1000 MY 09-16



FENDER BAG

- Perfect place to store gear and snacks
- Easy to access while seated
- Pockets hold water bottles

» 2876604
FITS ALL SPORTSMAN® MODELS



RIDE & REPAIR ESSENTIALS KIT / NEW

- 12-volt DC portable air compressor
- Tire repair kit with 6 plugs
- Basic first-aid kit with bandages, scissors, safety pins and more
- 12-volt jumper cables
- Duct tape - 300mm x 1 roll
- Zip ties - 150mm length
- Electrical tape
- Ratchet strap - 50mm
- Microfiber cloth
- Carry bag

» 2881207
» ALL SPORTSMAN® MODELS

KEEP YOUR COOL

Our new Polaris® Northstar™ coolers have the final say when it comes to keeping your food and drinks cold and protected. With thick insulated walls, Polaris® Northstar™ coolers keep ice frozen for days. But premium ice retention is only half of the story. These coolers are also tough as nails, and are recognized by the Interagency Grizzly Bear Committee as certified bear-proof. It's the perfect combination of super-effective cooling and ultimate durability.

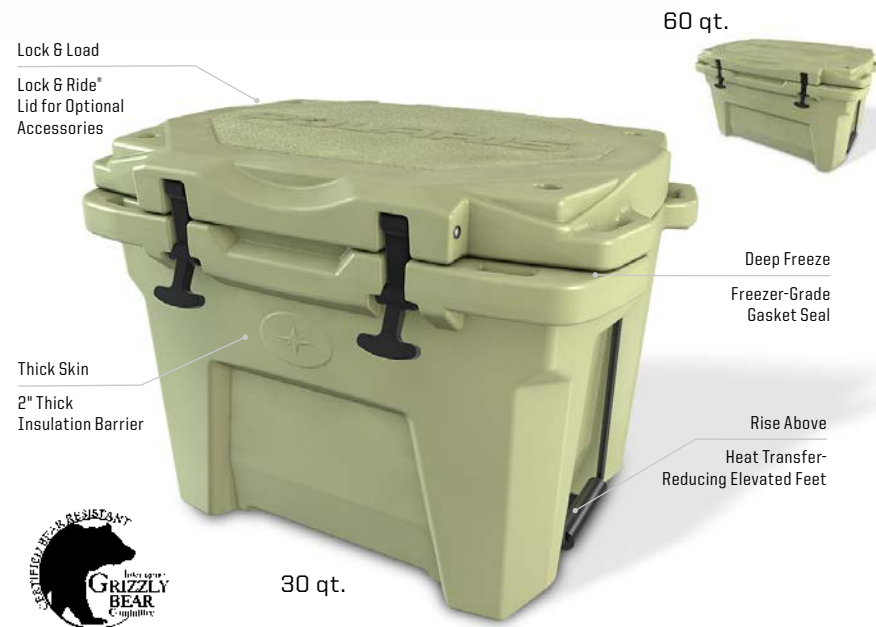

POLARIS® NORTHSTAR™ COOLER / NEW

- Thick 2-inch insulation barrier delivers premium, long-lasting cooling
- Integrated tie-down cleats enable attachment to any off-road vehicle, boat or truck
- UV resistant polyethylene construction
- Internal tray and dividers allows for dual dry storage solutions
- Available in both 30-quart and 60-quart sizes

» 2881315 | 30 qt.
 » 2881259 | 60 qt.
 ALL SPORTSMAN® MODELS



LOCK & RIDE® FRONT CARGO BOX

- Installs in seconds with Lock & Ride® technology
- Provides a covered, protected cargo space
- Latches down securely to keep cargo safe from rough weather, dirt and dust
- Additional cargo can be strapped onto the top surface of the Cargo Box with multiple tie-down points

» 2878235
 SPORTSMAN® 400/500/800 MY 11



SEMI-RIGID TOURING CARGO BAG

- Large-capacity, heavy-duty vinyl bag
- 3 zippered openings, removable dividers
- Attaches to rack with Velcro® straps

» 2877220
 SPORTSMAN® TOURING 500/800 MY 08-10, SPORTSMAN® 570 TOURING MY 14-16



LOCK & RIDE® REAR STORAGE BOXES

- Lock & Ride® for easy on and off
- Made of heavy-duty polyethylene
- 1,400 cu. in. (3,556 cu. cm) of storage volume
- Sealed for extra protection from moisture
- Sold in pairs

» 2878000
 SPORTSMAN® TOURING 550/850 MY 11-14, SPORTSMAN® 570 TOURING MY 14-16
 Slight interference with Sportsman® Touring 550/850 MY 11-14 passenger handles



LOCK & RIDE® BACKREST

- Fits with Lock & Ride® Gun Boot Mount and Rack Extenders
- Adds back support and riding comfort
- Locks in place in seconds
- Fully adjustable for all-day comfort
- Fits with Lock & Ride® Gun Boot Mount and Rack Extenders

» 2876616
 SPORTSMAN® XP MY 09-16, SPORTSMAN® 550/850/1000
 Does not fit with Lock & Ride® Cargo Box (2876601) installed

» 2879887
 SPORTSMAN® 570 MY 14-16, 570 SP MY 15-16, ETX MY 15-16

» 2878513
 SPORTSMAN® 500/800 MY 11-14
 Does not fit with Lock & Ride® Cargo Box 2876601 installed



LOCK & RIDE® GUN BOOT MOUNTS (NOT SHOWN)

- Lock & Ride®
- High-impact case secures firearm over any terrain
- Lock & Ride® system mounts on right
- Work with Cargo Box, Cargo Bag, Cargo Extenders

» 2878337
 SPORTSMAN® 400/500/800 MY 11-14

» 2876920
 SPORTSMAN® 500/600/700/800 MY 05-10

» 2877381
 SPORTSMAN® XP 550/850/1000 MY 09-16

» 2878001
 SPORTSMAN® TOURING 550/850/1000 MY 10-16

» 2876493
 SPORTSMAN® TOURING 500/800 MY 08-14

» 2875783
 SPORTSMAN® X2 500/550/570/800/850

» 2879888
 SPORTSMAN® 570 MY 14-16, SPORTSMAN® 570 TOURING MY 14-16



OGIO® SEMI-RIGID REAR BAG

- Exclusive Polaris® lid-mount dust gasket
- Internal storage compartments
- Two easy-fastening snap buckles
- Material is durable high-denier polyester fabric
- Lock & Ride® mounting atop the rear cargo rack
- Includes mounting hardware

» 2879911 | Polaris Pursuit® Camo
 SPORTSMAN® 400/550/550/570/SP/800, SPORTSMAN® XP 550/850/1000 MY 09-16,
 SPORTSMAN® 400/600/700/800 MY 05-13



OGIO® SEMI-RIGID REAR BAG

- Exclusive Polaris® lid-mount dust gasket
- Internal storage compartments
- Two easy-fastening snap buckles
- Material is durable high-denier polyester fabric
- Lock & Ride® mounting atop the rear cargo rack
- Includes mounting hardware

» 2879256 | Black
 SPORTSMAN® 400/550/550/570/SP/800, SPORTSMAN® XP 550/850/1000 MY 09-16,
 SPORTSMAN® 400/600/700/800 MY 05-13



Polaris is proud to partner with Kolpin Powersports. An industry leader in off-road accessories, Kolpin is the premier name in gun boots and mounts. Our featured Kolpin accessories are made exclusively for Polaris, and are designed to fit and work perfectly with your off-road vehicle.



POLARIS® GUN BOOTS BY KOLPIN®

- Securely protects and holds firearm
- Works with shotgun or rifle
- Padded interior, dust-proof, water-resistant

» 2872677 | Black
 ALL POLARIS® GUN BOOT® MOUNTS

» 2872677-419 | Mossy Oak®
 ALL POLARIS® GUN BOOT® MOUNTS



RHINO GRIPS XL BY KOLPIN® / NEW

- Securely transport tools or firearms with these rugged and easy to use grips
- The sure grip design ensures your cargo won't slip or work free in rugged terrain
- Rubber straps adjust to a variety of cargo sizes
- Requires minimal rack space and attaches using Lock & Ride® technology

» 2881513
 ALL SPORTSMAN® MODELS

RUBBER STRAPS BY KOLPIN® / NEW

- Replacement rubber straps designed to fit all Kolpin® grips (Sold as a pair)

» 2881621
 FIT KOLPIN ONON RATCHETING RHINO GRIPS



RATCHETING RHINO GRIPS XL BY KOLPIN® / NEW

- Securely transport tools or firearms with these rugged and easy to use grips
- The sure grip design ensures your cargo won't slip or work free in rugged terrain
- Premium ratcheting design securely conforms to a variety of cargo, ensuring secure storage
- Requires minimal rack space and attaches using Lock & Ride® technology

» 2881157
 ALL SPORTSMAN® MODELS



EXTEND YOUR RIDE TIME

Stay out longer with the help of our powerful and technologically superior lighting systems. No other manufacturer can match the range, peripheral lighting and quality found in every Polaris Engineered™ lighting component. When you're looking to take your lighting to the next level, look no further than Polaris®.



CANNON LIGHT / NEW

- 4" bullet style light produces 1052 Lumens of light
- Durable housing protects lights from rocks and debris
- Includes single 4" light, mount, clear euro cover, amber euro cover and amber spot cover

» 2881471
ALL SPORTSMAN® MODELS



13" LED LIGHT BAR

- Convenient, versatile lighting that will enhance your riding experience
- 13" LED Light Bar elevates the vehicle's sporty, high-performance style
- Polaris®-exclusive and manufactured by Vision X
- Installs quickly and easily into designated mounting locations and connects to vehicle's electrical system
- Delivers reliable performance and outstanding value
- Dustproof and waterproof up to one meter; tested to IP67 standards
- Premium 5-watt CREE XPG-2 LEDs
- 13.39" x 2.76" x 2.17" (34 cm x 7 cm x 5.5 cm)

» 2880530
ALL SPORTSMAN® MODELS



Requires LED harness (2879863 sold separately).
Installation instructions are included with the LED harness.



12" LIGHT BAR

- Convenient, versatile lighting that will enhance your riding experience
- 12" LED Light Bar elevates the vehicle's sporty, high-performance style
- Polaris®-exclusive and manufactured by Vision X
- Installs quickly and easily into designated mounting locations and connects to vehicle's electrical system
- Delivers reliable performance and outstanding value
- Premium 3-watt LED lights with max output of 2,100 lumens
- Custom combination of spot and flood lenses provide optimal light beam projection

» 2879500 | Black Housing
SPORTSMAN® XP FRONT BRUSHGUARD
Requires LED Light Bar Harness (2879863)



2" LED LIGHT

- Max output of 900 lumens
- Weatherproof connectors with plug-and-play harness
- Die-cast aluminum housing with interlocking omni-link system and stainless steel hardware

» 2878715
POLARIS® FRONT BRUSHGUARDS
Requires LED Light Bar Harness (2879863 or 2878770)



RALLY LIGHT

- 4" (10.2 cm) lens with 35-watt halogen bulb
- Sold individually

» 2877335
POLARIS® FRONT BRUSHGUARDS



BLUE XENON HEADLIGHT BULBS

- Over 50% brighter than stock bulbs
- 98% xenon gas, 12 volts, 50 watts

» 2876464
SPORTSMAN® XP MY 09-14, SPORTSMAN® MY 05-14

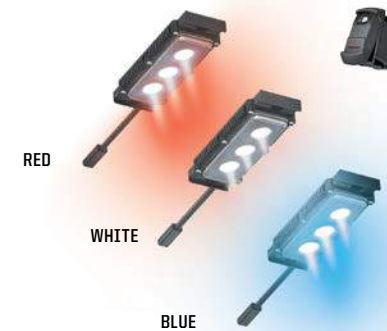

ACCENT LIGHTING KIT / NEW

- Set includes 4 LED pods
- Durable off-road ready construction that is both dust and water-resistant
- Features CREE LED for a long lasting brilliant light
- Easy to install in a variety of creative locations
- Control hub and complete instructions included

» 2880500 | Red
» 2880506 | Blue
» 2881119 | White
ALL SPORTSMAN® MODELS

SINGLE ACCENT LIGHT / NEW

» 2880532 | Red
» 2880533 | Blue
» 2881176 | White
ALL SPORTSMAN® MODELS

LIGHTING HARNESSES

UNIVERSAL LED HARNESS (NOT SHOWN)

» 2879863
ALL SPORTSMAN® MODELS
This harness is required for installation of LED Headlight Kits (sold separately)

DUAL LIGHT HARNESS (NOT SHOWN)

• Required for installation of 2" LED light
• Connections for 2 LED lights
» 2878770
ALL SPORTSMAN® MODELS

FRONT BUMPER WIRE HARNESS (NOT SHOWN)

» 2877910
ALL SPORTSMAN®/SPORTSMAN® XP MODELS

TECH & ELECTRONICS



POLARIS® INTERACTIVE DIGITAL DISPLAY 2.0

NEW FEATURES

- Control of Bluetooth® audio media streaming with track and artist display
- Backup camera display (if enabled and supported by hardware, will be shown when shifting to reverse)
- Forward camera display (if enabled and supported by hardware, will be added to the main screens when cycling using the far left button)
- Exporting capabilities for created tracks and waypoints from the display to USB drive
- Course up arrow option with rotating background map now available
- Distance to a selected waypoint shown on the map screen
- Automatic day/night brightness change based on time of day and day of year
- New riding screen with increased visibility to important diagnostics, gear indicator enlarges on gear change

STANDARD FEATURES

- High resolution, 4.3" full color LCD display
- Bluetooth® connectivity allows you to pair your smart phone and check missed calls, text message, battery life and signal strength
- Diagnostics screen displays vehicle fault codes (NEW: Voltage and engine temp faults will pop up and turn red at critical levels)
- GPS Connectivity offers exact location information including elevation, latitude/longitude and compass bearings

» 2881554
SPORTSMAN® XP 1000 TOURING, SPORTSMAN® 850, SPORTSMAN® 550 SP, SPORTSMAN® SP 850, SPORTSMAN® 550 TOURING, SPORTSMAN® 570 SP, SPORTSMAN® 570, SPORTSMAN® 570 TOURING, & SPORTSMAN® ETX
Must purchase SPORTSMAN® Install Kit (2880536)

POLARIS® INTERACTIVE DIGITAL DISPLAY INSTALL KIT

- Includes everything needed for installation of a Polaris® Interactive Digital Display unit on applicable Polaris® Sportsman® ATVs

» 2880536
SPORTSMAN® XP 1000 MY15-16, SPORTSMAN® 570 SP MY15-16



Connect your device and play your favorite songs



Check missed calls and text messages without pulling out your phone

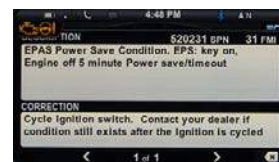

Diagnostics screen displays fault codes and suggested actions to take

TRANSFORM YOUR OFF-ROAD EXPERIENCE

Nothing will transform your riding experience as much as RiderX™. A multi-platform experience, RiderX™ is your adventure manager. Plan your routes, find new trails, monitor your vehicle and much, much more. RiderX™ features are accessible through the web, our RiderX™ app on your smartphone and in-vehicle integrations.

FOR MORE INFO, VISIT RIDERX.COM

INTRODUCING POLARIS® LINK POWERED BY RIDERX™

Become integrated into your riding experience with the Polaris® Link, powered by RiderX™. The wireless link easily plugs into your vehicle to record diagnostics and other valuable information. The data is then transferred wirelessly via Bluetooth® to your cellular device, where you can then review the data via the free RiderX™ mobile application. With Polaris® Link you can view real-time speed, rpm, fuel rate, mpg, and much more.

- Analyze real-time gauge with speed, RPM and average miles per gallon
 - View vehicle statistics including fuel rate, battery voltage engine hours and more
 - Review vehicle diagnostics such as possible error codes or preferred dealer communications and service reminders
- *Full functionality requires compatible Bluetooth® smartphones

POLARIS® WIRELESS LINK / NEW

» 2879855

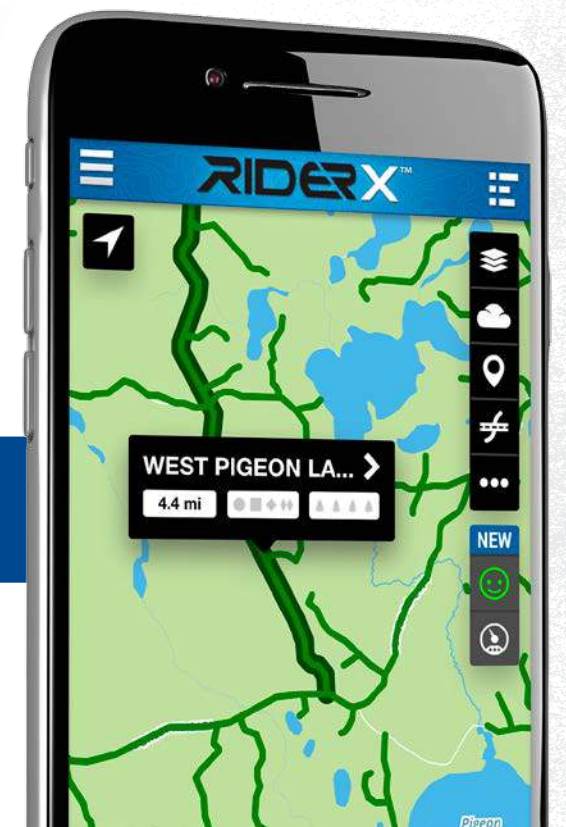

TO DOWNLOAD THE RIDERX™ APP

TEXT ORV1 TO 82350



TOP 3 NORTH AMERICAN RIDING DESTINATIONS



The Paiute ATV Trail - Utah, USA



Taylor Park - Colorado, USA



Coal Creek OHV Area - Tennessee, USA



PASSENGER FOOT RISERS

- Raise passenger foot rests 3" (7.6 cm) or 7" (17.8 cm)
- Increase comfort for shorter passengers
- Made of tough plastic, with non-slip surface

3" PASSENGER FOOT RISERS

- » 2877919
SPORTSMAN® TOURING 550/850 MY 10-14, SPORTSMAN® X2 550/850 MY 10-14
- » 2875782
SPORTSMAN® X2 500/800 MY 06-09, SPORTSMAN® TOURING 500/800 MY 08-13

7" PASSENGER FOOT RISERS

- » 2876885
SPORTSMAN® X2 MY 06-09, SPORTSMAN® TOURING 500/800 MY 08-14



HANDLEBAR-MOUNTED MIRROR

- For added safety on or off the trail

» 2877222

ALL SPORTSMAN® MODELS AND TRAIL BOSS®, TRAIL BLAZER®, SCRAMBLER® MY 10-14



HAND WARMERS

- Keep both hands warm while riding
- Complete kit includes all wiring

» 2877363

ALL SPORTSMAN® MODELS

» 2878302 | Passenger Hand Warmers
SPORTSMAN® TOURING 850/1000 MY 15-16



THROTTLE/THUMB WARMERS

- Keeps throttle thumb warm
- Complete kit includes all wiring

» 2877364

ALL SPORTSMAN® MODELS



LICENSE PLATE KIT

- Everything you need to create an ATV license plate

» 2873270

ALL SPORTSMAN® MODELS

LOCK & RIDE



LOCK & RIDE® ANCHOR

- » 2876420
REFER TO YOUR ACCESSORY INSTRUCTIONS FOR FITMENT



HORN KIT

» 2872897

SPORTSMAN® XP FOX® SHOCKS KIT (NOT SHOWN)

- Remote reservoir for outstanding performance
- Compression-adjustable to customize the ride
- Improves handling
- Rebuildable design

» 2879892

» SPORTSMAN® 850, SPORTSMAN® XP 1000



WHAT DO YOU LISTEN TO WHEN YOU'RE RIDING?

"ROCK ON THE ROCKS, COUNTRY ON THE TRAIL."

— TIM R., POLARIS OWNER



SOUND BAR 8 / **NEW**

- Six midrange/midbass speaker and two dedicated tweeters
- Integrated, self-powered amplifier for easy installation
- Bluetooth® or wired audio input with variable output
- Large easy-to-use external controls
- Aluminum, black finish housing with low profile, clamp-on mounts
- Includes mounts, audio bar, waterproof connections and instructions
- Excellent audio building block when paired with sub woofer and audio pods

» 2881465

ALL SPORTSMAN® MODELS

Available In September 2015



SOUND BAR 4 / **NEW**

- Dual midrange/midbass speaker and two dedicated tweeters
- Integrated self-powered amplifier for easy installation
- Bluetooth® or wired audio input with variable output
- Large, easy to use external controls.
- Aluminum, black finish housing with low profile clamp-on mounts
- Includes mounts, audio bar, waterproof connections and instructions
- Excellent audio building block when paired with sub woofer and audio pods

» 2881230

ALL SPORTSMAN® MODELS

Available In September 2015



AUDIO PODS / **NEW**

- Two 8" coaxial speakers with 1" titanium tweeters in weatherproof enclosures
- Self-powered 200-watt per speaker output
- Backlit LED illumination selectable between red and blue
- Rotating, low-profile, rubber isolated mounts
- Durable black satin finish
- Includes waterproof connections
- Requires audio harness, head unit or Bluetooth® Remote (2881470)

» 2881227

Available In September 2015



BLUETOOTH® AUDIO REMOTE / **NEW**

- Bluetooth® technology allows you to play music through speakers of choice
- Mount anywhere and control music with easy to use push-button pad
- Keep your iPod®, smart phone or tablet stowed way safely.
- Ideal addition to accessory Polaris® Audio Pods (2881227)

» 2881470

Available In September 2015



FRONT BUMPER AUDIO MOUNTING BAR

- Easily mount pod type speakers to your lifted or stock Sportsman®
- Speakers are powered by puck-style Bluetooth® module
- Rear mount doubles as a rack extender and features tie-down locations

» 2881461

SPORTSMAN XP® 1000 MY15-16, SPORTSMAN XP® 550 EPS MY09-14, SPORTSMAN XP® 850 EPS MY09-14, SPORTSMAN® XP 1000 HIGH LIFTER EDITION
AVAILABLE IN SEPTEMBER 2015



REAR BUMPER AUDIO MOUNTING BAR

- Easily mount pod type speakers to your lifted or stock Sportsman®
- Speakers are powered by puck-style Bluetooth® module
- Rear mount doubles as a rack extender and features tie-down locations

» 2881462

SPORTSMAN XP® 1000 MY15-16, SPORTSMAN XP® 550 EPS MY09-14, SPORTSMAN XP® 850 EPS MY09-14, SPORTSMAN® XP 1000 HIGH LIFTER EDITION
AVAILABLE IN SEPTEMBER 2015



POLARIS® RACK
Hard mounts using push darts, requires drilling

POLARIS® 570 SP,
850, 1000
Mounts around
speedometer and
pushes darts to the pod

POLARIS® 570, ETX
Mounts around
speedometer and
pushes darts to the pod

WATERPROOF BLUETOOTH® AUDIO

- MBQuart Audio Technology
- Kit includes four mounting configurations
- Self contained wireless audio unit provides a rider with rich, powerful, high-quality audio
- Mounts easily to the handlebars, roll cage or fits in your dashboard storage area
- IPX4 rated for water and dust resistance
- Simple controls on top of unit adjust volume and function
- Audio unit has Bluetooth® connectivity with voice prompts and voice commands (voice commands on iOS only)
- Internal LiPo rechargeable battery provides 12 hours of music between charges
- Unit can be easily removed from your ATV between rides for recharging and for use in other applications

» 2880458

ALL POLARIS® OFF-ROAD VEHICLES

SCRAMBLER



GET UP AND GO

For those that seek the pinnacle of performance, look no further than the Scrambler®. This performance ATV is designed to attack the trails with aggression and confidence.



REAR BASH GUARD

- Strong, durable, lightweight aluminum construction
- Protects drivetrain at rear of vehicle
- Engineered for easy installation
- Aggressive racing styling

» 2879138
SCRAMBLER® XP 850/1000 MY 13-15

LOCK & RIDE® WINDSHIELD (NOT SHOWN)

- Polaris®-exclusive Lock & Ride® technology
- Installs or removes quickly and easily
- Strong, durable, protective polycarbonate construction
- Mid-height, 15" tall, for excellent protection and visibility
- Smoke finish with custom Scrambler® XP 850 graphics

» 2879140
SCRAMBLER® XP 850 MY 13-16, SCRAMBLER® XP 1000

LARGE REAR RACK (NOT SHOWN)

- Polaris®-exclusive Lock & Ride® technology
- Installs or removes quickly and easily
- Strong, durable, lightweight tube construction
- Doubles the usable surface area of the rear rack
- Provides countless tie-down opportunities
- Black wrinkle-coat finish

» 2879139
SCRAMBLER® XP 850 MY 13-16, SCRAMBLER® XP 1000
Not compatible with Ogio® Scrambler® Bag part number (2879925)



HANDLEBAR HEADLIGHT

- Custom pod for integrated look and style
- 2 high-powered 1,800-lumen LED lights
- Provides directional lighting for better riding experience
- Durable, rugged die-cast aluminum housing
- Kit includes everything needed for easy installation

» 2879245
SCRAMBLER® XP 850 MY 13-16, SCRAMBLER® XP 1000

OGIO® SCRAMBLER® BAG

- Exclusive Polaris® lid-mounted dust gasket keeps contents of the bag free from debris and dust
- Semi-rigid bag provides a versatile, protected storage solution
- Semi-rigid construction holds its shape when empty, provides the fullest, most-accessible cargo space
- Premium materials and construction provide reliable weatherproof protection for cargo
- Multiple zippered compartments
- Large lid features overhang lip to seal out moisture and dust
- Polaris®-exclusive Lock & Ride® technology: Install/remove bag quickly and easily
- OGIO®- and Polaris®-branded

» 2879925
SCRAMBLER® XP 1000, SCRAMBLER® 850
Does not work with rear rack (2879139)

SCRAMBLER® 850 AND 1000 WINCH WIRING KIT

- Direct to harness connections for Scrambler® models
- Simplifies installation, no cutting or splicing
- Required for Polaris® Scrambler® 850 and 1000 winch installation

» 2879919
SCRAMBLER® XP 850 MY 13-16, SCRAMBLER® XP 1000 MY 15-16



HD WINCHES AND GLACIER® PLOWS

Available for Scrambler® XP 850. See page 10 for Winches and page 14 for Plows.

BRUSHGUARD

- Strong, durable, lightweight aluminum construction
- Protects front end of vehicle
- Engineered for easy installation
- Has mounting locations for auxiliary lights (sold separately)
- Aggressive styling looks great on vehicle
- Can be used with winch and plow

» 2879136
SCRAMBLER® XP 850 MY 13-16, SCRAMBLER® XP 1000

FOX® SUSPENSION

- Remote reservoir for outstanding performance
- Compression-adjustable to customize the ride
- Improves handling
- Rebuildable design

» 2879258
SCRAMBLER® XP 850 MY 13-16, SCRAMBLER® XP 1000

GOGGLES — PG 46

PROTECT

Equip yourself for the off-road. Our full line of quality riding gear is tested, developed and optimally styled for total performance.

HELMETS — PG 44-45

CASUAL WEAR — PG 50-55

STYLE

Wear your passion for off-roading wherever you go.

DRESS THE PART

Stay safe on the trail, look good off it. Whether you're looking for protective gear or comfortable casual wear, be confident knowing that Polaris® clothing and gear is as tough as it is stylish.

HELMETS



GREY FRACTAL



RED FRACTAL



ORANGE FRACTAL



BLUE FRACTAL



PODIUM 2



SLY



DOMINATE

FLY F2[®] HELMET

- Lightweight and impact resistant composite construction shell
- Aircraft grade woven carbon fiber and Kevlar[®] materials
- Dual density liner with two layers of energy absorbing material
- Removable washable liner and cheek pads feature plush sweat absorbing material
- Extensive through helmet cooling vents keep you comfortable in the heat
- Tri-flow goggle vents reduce fogging in cold or high humidity environments
- Custom molded trim and protective integrated nose guard.
- Snell[®] 2010 DOT and ECE approved
- Available in a wide range of colors and graphics
- Styled to match FLY[®] Off-Road Jersey and FLY[®] Off-Road Gloves

- » 2866203 | BLUE FRACTAL / **NEW** | XS-5XL
- » 2866201 | RED FRACTAL / **NEW** | XS-5XL
- » 2866202 | ORANGE FRACTAL / **NEW** | XS-5XL
- » 2866200 | GRAY FRACTAL / **NEW** | XS-5XL
- » 2866143 | PODIUM 2 | XS-5XL
- » 2865110 | SLY | XS-5XL
- » 2865112 | DOMINATE | XS-5XL

FLY F2[®] REPLACEMENT VISOR

- » 2866207 | REPLACEMENT VISOR- BLUE FRACTAL
- » 2866205 | REPLACEMENT VISOR- RED FRACTAL
- » 2866206 | REPLACEMENT VISOR- ORANGE FRACTAL
- » 2866204 | REPLACEMENT VISOR- GRAY FRACTAL

FLY F2[®] MOUTH PIECE

- » 2866211 | MOUTH PIECE- BLUE FRACTAL
- » 2866209 | MOUTH PIECE- RED FRACTAL
- » 2866210 | MOUTH PIECE- ORANGE FRACTAL
- » 2866208 | MOUTH PIECE- GRAY FRACTAL

FLY[®] REPLACEMENT PARTS

- » VISOR SCREW KIT | 2863162
- » COLD WEATHER PLUG KIT (XS/S) | 286316401
- » COLD WEATHER PLUG KIT (M/L) | 286316403
- » COLD WEATHER PLUG KIT (XL/2XL) | 286316409
- » BREATH DEFLECTOR | 2863165
- » CHEEK PAD-20MM | 2863195
- » CHEEK PAD-25MM (2XL) | 2863196
- » CHEEK PAD-30MM (L) | 2863197
- » CHEEK PAD-35MM (S, M, L) | 2863198
- » CHEEK PAD-40MM (XS) | 2863199

NEW IMPROVED FIT!
BETTER COMFORT. BETTER RIDE.
SEE IT IN ACTION AT POLARIS.COM/SHOP



Removable Breath Deflector

BLUE GLOSS



RED GLOSS



ORANGE GLOSS



BLACK GLOSS

DEMON HELMET

- Lightweight, protective composite fiberglass shell
- Dual density, removable EPS liner for impact absorption that is moisture-wicking QuickDry[®] and washable
- Aerodynamic, multi-channel flow-through ventilation system
- Snell[®] M2010 and DOT approved

- » 2866126 | RED GLOSS | XS-3XL
- » 2866127 | BLUE GLOSS | XS-3XL
- » 2866128 | ORANGE GLOSS | XS-3XL
- » 2866129 | BLACK GLOSS | XS-3XL

DEMON REPLACEMENT VISOR

- » RED GLOSS | 2866149
- » BLACK GLOSS | 2866150
- » ORANGE GLOSS | 2866151
- » BLUE GLOSS | 2866152

DEMON REPLACEMENT PARTS

- » BREATH DEFLECTOR | 2861233
- » VISOR SCREW KIT | 2869484
- » BREATH DEFLECTOR 2.0 | 2866153
- » CHIN CURTAIN 2.0 | 2866155



RED GLOSS



BLUE GLOSS



BLACK/LIME PUNCH



BLACK/GREY MATTE



BLACK MATTE

TENACITY HELMET

- Lightweight polycarbonate shell
- Removable, washable liner
- Mouth air intake vent, eyebrow vents and six rear vents
- 3XL size is DOT approved only

- » 2866132 | RED GLOSS | XS-3XL
- » 2866133 | BLUE GLOSS | XS-3XL
- » 2866134 | BLACK/LIME PUNCH | XS-3XL
- » 2866135 | BLACK/GREY MATTE | XS-3XL
- » 2866136 | BLACK | XS-3XL

TENACITY REPLACEMENT VISOR

- » RED GLOSS | 2866144
- » BLUE GLOSS | 2866145
- » BLACK/LIME PUNCH GLOSS | 2866146
- » BLACK/GRAY MATTE | 2866147
- » BLACK MATTE | 2860204

TENACITY REPLACEMENT PARTS

- » VISOR SCREW KIT | 2862120
- » BREATH DEFLECTOR | 2861233

HELMET SAFETY



A proper fit should be a little tight at first. It will loosen up a bit as the helmet is broken in.

There are three helmet safety ratings you'll commonly see:

- DOT (US Department of Transportation),
- ECE (UN Economic Commission for Europe)
- Snell (a non-profit organization dedicated to helmet safety).

Never buy or sell used helmets. The pads have formed to a specific head shape, and will not work properly on a different head.

Helmets are designed to endure a single moderate impact. If involved in any significant crash, replace your helmet.

GOGGLES

509[®] FOR POLARIS[®]

509[®] DIRT PRO GOGGLES / NEW

- Oversized frame for wide field of vision
- Precision fit lenses with optimal clarity
- Durable anti-scratch and anti-fog lens coating
- Available replacement lenses including chrome, polarized and clear
- Hinged strap ensures a more positive fit on face
- Triple layer foam for added comfort and moisture wicking
- 13-port in goggle venting promotes fresh ventilation
- Integrated and removable vented nose guard for added protection
- Sturdy three-post tear-off compatible (Requires Tear Off Pack 2863433)
- Perfect addition to FLY F2[®] Helmet and FLY[®] Off-Road Jersey

- » 2866212 | BLACK STANDARD (CLEAR LENS) | OSFM
- » 2866213 | ORANGE FRACTAL (CHROME LENS) | OSFM
- » 2866214 | BLUE FRACTAL (CHROME LENS) | OSFM
- » 2866215 | RED TECH (FIRE LENS) | OSFM
- » 2866216 | LIME TECH (CHROME LENS) | OSFM
- » 2866217 | RED FRACTAL (CHROME LENS) | OSFM

509[®] DIRT PRO REPLACEMENT LENSES (NOT SHOWN)

- » 2863430 | CHROME | OSFM
- » 2863431 | CLEAR | OSFM
- » 2863432 | BROWN POLARIZED | OSFM
- » 2863433 | TEAR-OFFS | 6 PER PACK | OSFM



RED TECH



ORANGE FRACTAL



BLUE FRACTAL



RED FRACTAL



BLACK STANDARD



LIME TECH



POLARIS[®] TRAIL GOGGLES

- » 2863434 | BLACK | OSFM

POLARIS[®] TRAIL GOGGLES REPLACEMENT LENS (NOT SHOWN)

- » 2863482 | CLEAR | OSFM

GLOVES



ORANGE FRACTAL

BLUE FRACTAL

RED FRACTAL

GRAY FRACTAL

FLY[®] OFF-ROAD GLOVES / NEW

- Outstanding protection, grip and comfort
- Lycra[®] back panels stretch for a perfect fit
- Soft-Flex TPR and embossed neoprene flex-knuckle system deliver protection
- Adjustable wrist closures for an assured fit
- Silicone finger grippers for wet driving conditions
- Reinforced thumb for long life durability
- Padded palm for added comfort and warmth
- Available in several colors to match your vehicle and gear
- Ideally suited for FLY[®] Off-Road Jersey and FLY F2[®] helmet

- » 2866218 | GRAY FRACTAL | S-3X
- » 2866219 | RED FRACTAL | S-3X
- » 2866220 | ORANGE FRACTAL | S-3X
- » 2866221 | BLUE FRACTAL | S-3X

JERSEYS



GRAY

PINK

ORANGE

RED

FLY[®] OFF-ROAD JERSEY / NEW

- Lightweight 100% polyester material in integrated mesh ventilation
- Vibrant sublimated graphics for high visibility and style
- Low profile, multi-directional Lycra[®] stretch collar for comfort
- Non-restrictive shorty cuffs and elastic sleeves for wide range of motion
- Extended tail keeps jersey tucked into pants
- Tagless design for irritation free comfort
- Available in five colors: gray, red, pink, orange and blue
- Matching FLY F2[®] helmet and FLY[®] Off-Road glove available

- » 2866222 | GREY | S-3X
- » 2866223 | RED | S-3X
- » 2866224 | PINK | S-3X
- » 2866225 | ORANGE | S-3X

PROTECTION



TEKVEST® FREESTYLE

- SHELL: Strong, protective UHMW panels cover shoulders; front and rear mesh panels promote cooling airflow
- FIT: Adjustable strap system for perfect fit
- SAFETY: Optional quick-attach shoulder pads available for upper arm coverage
- ADDITIONAL FEATURES: Large arm openings for unrestricted movement; can be used for snowmobiling and off-roading

» 2862189 | S-3X



TEKVEST® SUPER SPORT

- SHELL: Strong, protective UHMW panels cover shoulders
- FIT: Adjustable belt across lower back ensures proper fit
- SAFETY: Optional quick-attach shoulder pads available for upper arm coverage
- ADDITIONAL FEATURES: Zip-off fleece collar diffuses rising body heat to reduce fogging; large arm openings for unrestricted movement; drop-tail design for extended coverage; 2-stage pockets; can be used for snowmobiling and off-roading

» 2862190 | S-3X



YOUTH TEKVEST® (70-100 LB)

- SHELL: Strong, protective UHMW panels cover shoulders
- FIT: Adjustable side straps and arm straps
- SAFETY: Shoulder pads are included for upper arm protection

» 2862191



TEKVEST® SHOULDER PADS

- Quick-attach shoulder pads allow for upper arm coverage

» 2862192 | S-3X

YOUTH



INTRODUCING KIDS TO RIDING

- » Before anything else, make sure they have a youth helmet that fits properly.
- » Don't start your kids on a machine that's too powerful. Have 6-8 year olds begin with a 50cc ATV and a RZR® 170 for those 10-12.
- » Invest in quality bumpers & brushguards. Little accidents are going to happen.
- » Understanding terrain is essential. Teach them how to read and react to changing conditions.
- » Keep it fun. After all, that's what off-road riding is all about.



YOUTH FLY® OFF-ROAD JERSEY / NEW

All the same great features of our full-size jersey in a youth size. Enjoy the comfort fit, high-flow ventilation, wide range of movement and convenient features in your choice of red or pink color schemes. Why should adults have all the style?

- » 2866227 | Red Fractal | S-3X
- » 2866228 | Pink Fractal | S-3X



YOUTH MX HELMET

- » 2860174 | BLACK | S-M-L
- » 2862171 | RED | S-M-L
- » 2862172 | BLUE | S-M-L



YOUTH RZ MASK

» 2863191 | OSFM

YOUTH RZ MASK REPLACEMENT FILTERS (NOT SHOWN)

» 2863192 | OSFM | 3 per pack

POLARIS® YOUTH GOGGLES

» 2863435 | OSFM



YOUTH AERO GLOVES

» 2862187 | S-M-L



BEANIES & CAPS



YOUTH REVERSIBLE PRINTED BEANIE

- 100% Acrylic
- Soft screen print
- » 2866190 | GREY CRACKED | OSFM
- » 2866191 | PINK GEO | OSFM



SIGNATURE BEANIE

- 100% Acrylic with 3M® Thinsulate®
- » 2865141 | BLACK/CHARCOAL | OSFM
- » 2865142 | BLACK/RED | OSFM



MEN'S TRUCKER CAP

- 100% Cotton front panels on the back and bill
- 100% Polyester mesh back panels
- Snap back closure
- » 2865103 | OSFM



TEAM CAP

- Cotton twill
- Retro logos
- » 2865145 | OSFM



MEN'S THROWBACK

- Wool/spandex blend
- Flexfit sizing S/M and L/XL
- Metal retro Polaris® "P" logo
- » 2865144 | S/M
- » 2865138 | L/XL

LAYERING



MEN'S U.P. BASE LAYER

- 93% polyester and 7% spandex jersey knit
- Reflective logos
- Lightest weight layering piece in the line-up
- » TOP | 2864030 | S-3X
- » BOTTOM | 2864031 | S-3X



MEN'S KLONDIKE BASE LAYER

- 93% polyester, 7% spandex jersey knit
- Reflective logos
- Warmest layering piece in the line-up
- Soft-brushed liner for added warmth
- » TOP | 2866006 | S-3X
- » BOTTOM | 2866007 | S-3X



WOMEN'S KLONDIKE BASE LAYER

- 92% Polyester, 8% Spandex
- Soft-brushed liner for added warmth
- » TOP | 2866025 | S-3X
- » BOTTOM | 2866026 | S-3X



ANNAPURNA MID LAYER

- 100% polyester polar fleece, anti-static/anti-pill
- Zippered hand warmer pockets
- Contrast zipper, trim and cuffs
- Polaris® logo on left chest; ellipse on back of shoulders
- » 2864020 | BLACK | S-5XL
- » 2864019 | NAVY | S-5XL



OPS TECH LONG SLEEVE

- Effective mid-layer in layering system
- AP-360® wicking and antimicrobial
- Excellent moisture wicking performance
- Far-infrared (heat enhancing), anti-static, anti-pill
- » 2864096 | S-5XL

MEN'S APPAREL



CRACKED HOODIE

- 100% cotton
 - Heat transfer technology
 - Fleece liner
 - YKK® zippers with custom puller
- » 2866011 | S-3X



COLOR BLOCKED HOODIE

- 100% cotton
 - Fleece liner
 - Embroidered Polaris® logo
- » 2866010 | S-3X



BACKCOUNTRY HOODIE

- 95% cotton, 5% spandex
 - French terry
 - Embroidered logo
- » 2866012 | S-5X



PS-4 EXTREME PIT SHIRT

- 100% Cotton
 - Woven fabric
 - Embroidered logo
- » 2866042 | S-5X



VES PIT SHIRT

- 100% cotton woven fabric
 - Embroidered logo
- » 2866043 | S-5X



LONG SLEEVE TECH QUARTER ZIP

- 92% Polyester, 8% Spandex
 - Heat Transfer technology
- » 2866008 | S-3X



SPORT LONG SLEEVE

- 100% polyester silk
 - Heat Transfer technology
- » 2866061 | S-3X



BASEBALL LONG SLEEVE TEE

- 100% cotton,
 - Water-based screen print
- » 2866005 | S-5X



TECH POLO

- 100% polyester mesh
 - Wicking treatment technology
 - Embroidered logo
- » 2866009 | S-5X



POLARIS® SPORT SHORT SLEEVE

- 100% polyester silk
 - Heat transfer technology
- » 2866000 | S-3X



BLUE CRACKED TEE

- 100% cotton
 - Water-based screen print
- » 2866001 | S-3X



RUGGED CLOTHING FOR RUGGED RIDERS

IT'S NOT JUST POLARIS VEHICLES AND ACCESSORIES THAT ARE TOUGH. DESIGNED FOR AND BY AVID OFF-ROAD RIDERS, POLARIS® GEAR AND APPAREL WILL WITHSTAND YOUR ROUGH-AND-TUMBLE LIFESTYLE. AND OF COURSE, OUR CLOTHING LOOKS GREAT AND IS INCREDIBLY COMFORTABLE, TOO.

WOMEN'S APPAREL



WOMEN'S FULL ZIP FLEECE

- 100% polyester
- Micro fleece
- » 2866027 | Black/Pink | XS-5X
- » 2866028 | Blue/Purple | XS-5X



WOMEN'S KAUMAJET HALF ZIP

- 85% polyester and 5% spandex blend
- 2-needle cover stitch at bottom, sleeves, and body
- Upper collar and center back neck embroidery
- Self-fabric neck taping center front to opposite center front
- » 2865098 | XS-2X



WOMEN'S FLEECE VEST

- 100% polyester
- Micro fleece
- » 2866029 | XS-3X



WOMEN'S CARVED SWEATSHIRT

- 100% cotton
- Fleece liner
- Shoulder zip
- » 2866031 | XS-3X



WOMEN'S ASYMMETRICAL HOODIE / NEW

- 95% cotton, 5% spandex
- French terry
- » 2866033 | XS-3X



WOMEN'S RETRO HOODIE

- 95% cotton, 5% spandex
- French terry
- » 2866030 | XS-5X



WOMEN'S TECH QUARTER ZIP

- 92% Polyester
- 8% spandex
- » 2866032 | XS-3X



WOMEN'S RETRO 3/4 SLEEVE TEE

- » 2866022 | XS-3X



WOMEN'S LONG SLEEVE BASEBALL T-SHIRT

- 100% cotton
- » 2866023 | XS-5X



WOMEN'S SHORT SLEEVE TEE

- 100% cotton
- » 2866024 | XS-3X

YOUTH APPAREL



YOUTH CRACKED HOODIE

- 60th Hoodie
- 100% cotton
- 180 GSM face, 130gsm
- Fleece liner

» 2866037 | S-XL



YOUTH RETRO HOODIE

- 95% cotton, 5% spandex
- French terry

» 2866039 | S-XL



YOUTH FULL ZIP ICE FLEECE

- 100% polyester
- Micro fleece

» 2866040 | S-XL

SIZING CHARTS

HOW TO MEASURE

1. HEAD: Measure circumference of head just above top of ears, and 1 inch (2.54 cm) above eyebrows.
2. SLEEVE: With your arm fully extended, measure from the center back of neck at spine to the wrist bone.
3. CHEST: Measure under arms around the fullest part of the chest. Be sure to keep tape level across back and comfortably loose.
4. WAIST: Measure around natural waist with loose tape.
5. HIP/SEAT: Place the measuring tape around the body at the fullest part of the lower hip, feet together.
6. INSEAM: Without shoes; measure on inside of leg from groin to the floor.
7. GLOVE SIZE: Measure circumference around your dominant palm at widest point.
XS 5"-7" S 7"-8" M 8"-9" L 9"-10" XL 10"-11" 2XL 11"-12" 3XL 12"-13"

MEN'S SIZING						
SIZE	CHEST	WAIST	HIPS	SLEEVE	INSEAM	SIZE CODE
Small	34-36	31-33	34-36	27-28	30	02
Medium	38-40	35-37	38-40	29-30	31	03
Large	42-44	39-41	42-44	31-32	32	06
X-Large	46-48	43-45	46-48	33-34	33	09
2X-Large	50-52	47-49	50-52	35-36	33	12
3X-Large	54-56	51-53	54-56	35-36	33	14
4X-Large	58-60	55-57	58-60	33-34	33	15
5X-Large	62-64	59-61	62-64	33-34	33	16
Med Tall	38-40	35-37	38-40	29-30	34	05
Large Tall	42-44	39-41	42-44	31-32	35	08
XL Tall	46-48	43-45	46-48	33-34	36	11
2XL Tall	50-52	47-49	50-52	35-36	36	13

WOMEN'S SIZING						
SIZE	CHEST	WAIST	HIPS	SLEEVE	INSEAM	SIZE CODE
X-Small	29-31	21-24	30-33	29	29	02
Small	32-34	25-28	34-37	29	29	02
Medium	35-38	29-32	38-41	30	30	03
Large	39-42	33-36	42-45	31	31	06
X-Large	43-46	37-40	46-49	31	31	09
2X-Large	47-50	41-44	50-53	31	31	12
2X-Large	51-54	45-48	54-57	31	31	15

YOUTH SIZING						
SIZE	CHEST	WAIST	SLEEVE	INSEAM	SIZE CODE	
X-Small	22-23	20-21	14-17	15	01	
Small	24-25	22-23	18-21	18	02	
Medium	26-27	24-25	22-23	21	03	
Large	28-29	26-27	23-24	23	06	
X-Large	30-31	28-29	24-25	32.5	09	

ADULT HELMET SIZE CONVERSIONS				
SIZE	HAT SIZE	INCHES	METRIC	SIZE CODE
X-Small	6.75	21.25	54	01
Small	6.875-7	21.625-22	55-56	02
Medium	7.125-7.25	22.375-22.75	57-58	03
Large	7.5	23.125-23.625	59-60	06
X-Large	7.625-7.75	24-24.375	61-62	09
2X-Large	7.875-8	24.75-25.125	63-64	12
3X-Large	8	25-26	65	14

YOUTH HELMET SIZE CONVERSIONS			
SIZE	CIRCUMFERENCE	METRIC	SIZE CODE
Adjustable	Fits S-L	51-54	00
Small	20.375	51	02
Medium	20.875	53	03
Large	21.375	55	06

OGIO® BAGS



OGIO® 9800 ROLLER BAG

- SLED (Structural Load Equalizing Deck) System for increased durability and handling in the harshest of conditions
- Wide mouth LID opening for easy access to all gear compartments
- Large main compartment with adjustable dividers and padded helmet chamber
- iFOM (integrated foam) construction throughout for added gear protection
- Heavy duty oversized wheels with extra clearance
- Telescoping pull handle

» 2864212



OGIO® 8800 TRUCKER

- Wide Mouth U-Shaped opening for easy access
- Large main ventilated compartment and dual end pockets
- Telescoping pull handle and padded adjustable shoulder strap

» 2864213



OGIO® LOADER 7600

- Large main compartment with easy access opening
- Multi-use large end pocket
- Heavy duty shoulder carry straps with adjustable closure
- Durable reinforced bottom

» 2864214



OGIO® ENDURANCE DUFFEL BAG

- Large wide mouth U-shaped easy access opening
- Specialized shoe compartment
- Dual end and side zippered and accessory pockets
- Custom ergonomic molded interlocking handle
- Padded adjustable shoulder strap

» 2864215



OGIO® BANDIT BACKPACK

- Dedicated fleece lined top loading laptop compartment
- Two fleece lined valuables stash pockets
- Water bottle pocket with bottle lock feature
- Deluxe organization panel with zippered stash pocket
- Soft touch padded neoprene grab handle

» 2864216



OGIO® WATERPROOF BACKPACK

- Completely waterproof roll top construction
- Off-center removable hip belt
- Quick access front zippered stash pocket
- Dual density shoulder straps for maximum comfort

» 2864217

GIFTS / NEW



GLASSES

» 2866265 | POLARIS® PINT GLASS - Set of 2



TRAVEL

» 2866248 | POLARIS® TRAVEL MUG
» 2866249 | POLARIS® WATER BOTTLE



KEY CHAIN

» 2866252 | POLARIS® KEY CHAIN



MONEY CLIP

» 2866255 | POLARIS® MONEY CLIP/POCKET KNIFE



STICKERS

» 2866256 | POLARIS® VINYL WINDOW STICKER
» 2866257 | POLARIS® 6" STICKER
» 2866258 | POLARIS® 12" STICKER
» 2866259 | POLARIS® 24" STICKER
» 2866260 | POLARIS® 48" STICKER

USE THE BEST FOR YOUR MACHINE — PS-4 & POLARIS ENGINEERED LUBRICANTS* — PG 64-65

TOOLS AT THE READY — PORTABLE WORKSTATION — PG 58

CLEAN AND MEAN — VEHICLE CARE PRODUCTS — PG 63

POWER UP — POLARIS POWER® INVERTER GENERATORS — PG 60

WRENCH AT ANY LEVEL — X3 CREEPER — PG 59

GET UNDER IT — VEHICLE LIFT — PG 59

STOCK THE GARAGE IN YOUR FAVOR

Parts, lubricants, tool chests, lifts and generators — Polaris® has all of the highest-quality products to keep your off-road vehicle running at peak performance.



"THE NEW POLARIS ENGINEERED™ VEHICLE CARE PRODUCTS ARE GAME CHANGERS. I RACE IN A DIRTY ENVIRONMENT AND USING MUD SHIELD IS THE ULTIMATE ADVANTAGE IN KEEPING THE CAR LIGHT AND THE SPONSORS ON THE SIDE HAPPY!"

— RJ ANDERSON POLARIS® OFF-ROAD RACER #37

TOOL CHESTS / NEW

READY TO WRENCH

If you've got a set of high-quality tools, keep them organized and protected in Polaris' line of premium tool chests and workstations. In the garage or in your vehicle - they go where you need them the most.

POLARIS® ROLLER TOOL CABINETS & CHESTS

- Raise and release drawer pulls keeps drawers secure when moving
- Drawers use roller bearing glides
- Full width wrap-around aluminum drawer pulls
- Tubular theft proof lock and keys



POLARIS® 30" 5-DRAWER ROLLER CABINET



POLARIS® 41" 11-DRAWER ROLLER CABINET

POLARIS® 30" 5-DRAWER ROLLER CABINET

- 30 $\frac{3}{4}$ " W x 41" H x 20 $\frac{1}{2}$ " D

» 2830406 | Textured Finish

POLARIS® 41" 11-DRAWER ROLLER CABINET

- 41" W x 41 $\frac{1}{2}$ " H x 18" D

» 2830408 | Textured Finish
» 2830451 | High Gloss Finish

POLARIS® 41" STANDARD TOP CHEST



POLARIS® 41" STANDARD TOP CHEST

- 40 $\frac{1}{2}$ " W x 20 $\frac{3}{4}$ " H x 19 $\frac{3}{4}$ " D

» 2830450 | High Gloss Finish



STACK THEM UP: For even more storage stack the Polaris 41" Standard Top or Workstation and Roller Cabinet together



POLARIS® 30" PORTABLE WORKSTATION

- 30 $\frac{3}{4}$ " W x 20 $\frac{1}{2}$ " H x 17 $\frac{1}{2}$ " D
- 18-gauge steel construction
- Power tool rack with built-in power strip and 2 USB ports
- 35 wrench slots
- 186 socket pegs
- 48 driver holders
- Lockable lid
- Gas spring raises lid when unlatched for easy access

» 2830405
Tools not included



POLARIS® 41" PORTABLE WORKSTATION

- 41" W x 21 $\frac{1}{2}$ " H x 17 $\frac{1}{2}$ " D
- 16-gauge steel construction
- Power tool rack with built-in power strip and 2 USB ports
- 39 wrench slots
- 222 socket pegs
- 47 driver holders
- Socket tray lifts to access more tool storage underneath
- Lockable lid with double cut keys

» 2830407
Tools not included



POLARIS® HAND TOOL CADDY

- Heavy-duty steel finished in silver powder-coat
- Hangs from fence rail of roller tool cabinets
- Holds tools, rags, spray cans and more

» 2830431
Tools not included



POLARIS® POWER TOOL CADDY

- Heavy-duty steel finished in silver powder-coat
- Hangs from fence rail of roller tool cabinets
- Holds up to four power tools

» 2830430
Tools not included



POLARIS® BADGE

- Add RZR® or Ranger® badges to customize your roller cabinet or workstation

» 2830412 | RZR®
» 2830413 | RANGER®

CUSTOMIZE YOUR TOOL CHEST

WITH POLARIS® GRAPHIC PACKAGES
VIEW THEM ALL AT POLARIS.COM

SHOP PRODUCTS / NEW

POLARIS® VEHICLE LIFT

- Easily and safely lifts vehicles
- Operates using convenient foot pedal or lifts effortlessly with compressed air (approximately 125psi)
- Specifically designed to lift and secure off-road utility vehicles offering a tremendous safety advantage as opposed to the use of jacks and stands designed to lift and hold cars
- Positive dual locking safety catch

» 2830424 | 1,250 lb.
» 2830425 | 2,300lb.

POLARIS® VEHICLE LIFT ATTACHMENTS

- » 2830426 | Snowmobile Attachment
- » 2830427 | ATV/Polaris ACE® Attachment
- » 2830428 | RZR®/RANGER® Attachment



POLARIS® X3 CREEPER

- Sturdy steel frame construction
- Maximum 450 lb. working capacity
- 3 working positions: sit, recline and flat
- Ultra low flat position that is up to a full 2" lower than other creeper designs
- Six full-bearing, oil-resistant, solid PVC casters that are non-marking

» 2830429



POLARIS® MAGNETIC PARTS TRAY

- Keeps nuts, bolts, fasteners and small tools within easy reach
- Soft, rubberized covering over magnets prevents damage to finished surfaces
- Corrosion resistant stainless steel tray
- 5.375" W x 9.365" L x 1.25" D

» 2830432



POLARIS® 12" HI-TORQUE RATCHETING DRIVER

- Stainless steel shaft with fixed position tip
- Forward and reverse ratcheting action
- Rated up to 250 inch-pounds (35 kg/m) of torque
- Convenient bit storage inside handle
- Screwdriver bits made of S2 steel

» 2830434



GREASE GUN KIT

- Tough steel construction and pistol grip design
- Front and top-pipe outlet mounts accept both 6" rigid pipe nozzle and 12" 12,000 psi flex hose
- Comes with standard zerk fitting

» 2871312 | 4 per case



POLARIS® LED POCKET FLASHLIGHT

- Bright 1 watt LED bulb generates 90 Lumens of light
- Capable of lighting up to 200-feet
- Includes two AAA Duracell® batteries

» 2830436



POLARIS® 33" TELESCOPIC MAGNET

- Strong magnetic pick-up end
- Extends from 6.5" to 33"
- Up to 5-pounds of holding strength
- Features shielded side for targeted pickup
- Easy to grip, Polaris® branded handle

» 2830435



POLARIS® SHOP TOWELS

- Durable blue shop towels work like cloth
- Contains 50% post consumer and industrial recycled fibers
- Ideal for medium to heavy duty cleaning

» 2830402 | 200ct
» 2830440 | 64ct
» 2830403 | 200ct Refill
6 rolls per case



POLARIS® HEAVY DUTY SCRUBBER WIPES- 90CT

- Multipurpose cleaning towels with built-in solvent-free cleaning formula
- Removes grease, ink, tar, paint and more
- Conditions hands while it cleans with aloe, jojoba, wheat germ extract, and vitamins
- Features a textured cleaning surface for really tough jobs
- Water rejuvenation extends life of towels

» 2830441

GENERATORS



POLARIS POWER® INVERTER GENERATORS

Polaris Power® portable digital inverter generators are built for your outdoor lifestyle and are tested to the same rigorous standards as every Polaris® product.

- ▶ P136DGANA | 1000 Watt
- ▶ P136DG8NA | 2000 Watt
- ▶ P136DG6CNA | 3000 Watt



POLARIS POWER® PARALLEL KIT

- Increase total power output by connecting two Polaris® inverter generators together
- Any combination of two Polaris® parallel-ready inverter generators can be connected (P2000i and a P1000i, two P2000i models or two P1000i models)
- CETL Certified
- 1 Year Product Warranty
- 3200 Watt Maximum Output, 26.7A, 60 Hz
- Auto frequency matching and load distribution to each Polaris Power® Inverter Generator so neither is overloaded
- 30A twist lock receptacle, 120v

▶ 3410281



POLARIS POWER® TIE-DOWN LEADS / NEW

- Secure your Polaris Power® Generator by inserting the Lock & Ride® Tie Down Leads into the handle and running a strap across to tie down the generator
- Secures Lock & Ride® accepting gear
- Safely provides a point for 1" wide tie down strap

▶ 2880959



POLARIS POWER® GENERATOR OIL

- Polaris Engineering™ tested and approved
- Specifically formulated for Polaris Power® Inverter Generators
- Corrosion inhibitors protect against rust and oxidation during long-term storage
- Easy starting in extreme cold environments

▶ 2879383 | 1 qt. | 12 per case



POLARIS POWER® COLD WEATHER KIT / NEW

- Ensure smooth running of your Polaris® Generator in sub-zero temperatures
- Prevents ice blockage in the crankcase breather tube, which may lead to operational issues including oil leakage
- Installation required, no need to disconnect for warm weather operation
- Exclusively designed for use with Polaris® P1000i & P2000i inverter generators

▶ 2881433



POLARIS POWER® INVERTER GENERATOR COVER

- Custom fitting storage covers to keep your generator safe from the elements when not in use
- Built in pocket for owner's manual & DC charge cable
- Strong durable material, resistant to mold, mildew, tears & abrasions

▶ 2686441 | 1000 Watt
▶ 2686442 | 2000 Watt
▶ 2686443 | 3000 Watt

BATTERY CARE / NEW



BATTERYMINDER® 2012 AGM - 2 AMP

- Designed for High-Performance Specialty AGM Sealed batteries
- Microprocessor controlled 12-volt, 2-amp charger/maintainer/desulfator
- Weatherproof design for use in a wide range of conditions
- Built-in battery condition indicator
- Worldwide 100-240 VAC 50/60 Hz. Input
- Temperature Sensor-Compensator (prevents potential over/under charging from 32°F - 130°F)
- Recovers deeply discharged batteries
- Maintains multiple batteries
- Manufacturer's One-Year 100% Money Back Guarantee and 5-year "No Hassle" Warranty
- Includes: 6-foot AC cord and 6-foot DC cord with quick connector

▶ 2830438



BATTERYMINDER® 1510 - 1.5 AMP

- Installed ambient temperature sensor for 0°F-130°F operating range ensures the battery will never be overcharged or undercharged regardless of temperature extremes
- Worldwide 100-240 VAC 50/60 Hz input
- Recovers deeply discharged batteries
- Automatic Full-Time high frequency (not high voltage) pulse type desulfation
- Reverse polarity, short circuit and over temperature protection
- Extends battery life up to four times when compared to new batteries not being properly charged-maintained over their lifetime.
- Manufacturer's One-Year 100% Money Back Guarantee and 10-year "No Hassle" Warranty
- Includes: 12ft. power cord, BC-AA: Insulated Battery Clip Cord Set, Optional Permanent Mounting Tab, Ring Terminal Assembly with Quick Connector

▶ 2830404



BATTERYMINDER® RING TERMINALS

- Features 24-inch long 18-gauge wire
- Plug has standard 5/16" negative and 3/8" positive terminals
- Replaceable 15-amp in-line fuse for circuit protection
- Uses SAE quick connector and cap

▶ 2830437



BATTERYMINDER® SPLITTER

A simple, safe and affordable way to connect 2 batteries simultaneously for easy battery maintenance, includes a set of ring terminals

▶ 2830409



BATTERYMINDER® 12' CABLE

Made with heavy-duty 16-ga. black zip cord featuring automotive SAE bullet connectors

▶ 2830410



BATTERYMINDER® EZ CONNECT

Allows for quick and easy connecting and disconnecting of your BatteryMINDER®, includes a set of ring terminals

▶ 2830411

TRAILERS & ACCESSORIES

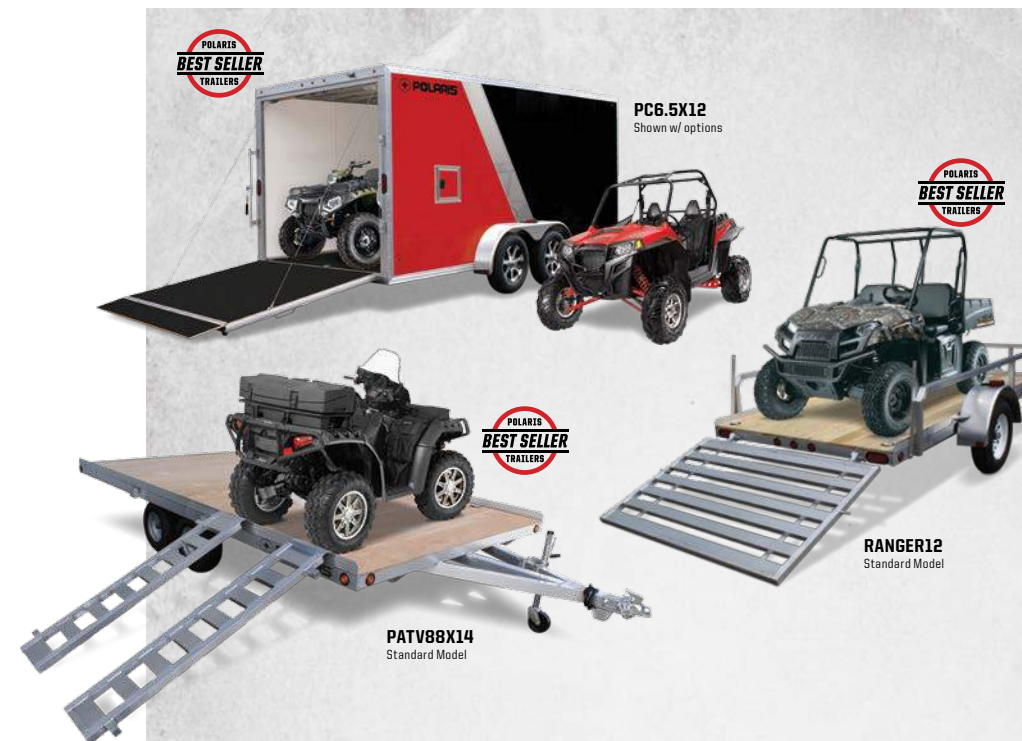

LOAD 'EM UP

Polaris® trailers are the ultimate combination of quality and versatility. With a variety of styles, sizes and price points to choose from, there is a trailer ready for you.

VIEW ALL TRAILER MODELS: POLARIS-TRAILERS.COM



STEEL UTILITY CART – TANDEM AXLE

- Tandem, sealed-bearing axle design; articulating center pivot provides reliable travel over rough terrain
- Cart has a 1000-lb. (453.6kg) payload capacity
- Holds up to 17 cu. ft. (5.2 cu. m)
- Drop-down tailgate for easy loading and dumping
- 18" x 9.5" x 8" (45.7 x 24.13 x 20.3 cm) off-road tires
- Interior size 57.7" x 31.7" x 12"

▶ 2878231

TIE-DOWN RATCHET STRAPS

- ▶ 2859047-01 | Red
- ▶ 2859047-02 | Black



TIE-DOWN STRAPS

- ▶ 2871181 | Black



LOCKING ½" HITCH PIN

- ▶ 2877638



TRAILER BALLS - ¾" SHANK

- ▶ 2877602 | 1 ½"
- ▶ 2877603 | 2"



RECEIVER HITCH

- ▶ 2877981 | 1 ¼ Receiver-3" Drop
- ▶ 2877476 | 1 ¼ Receiver-1" Drop
- ▶ 2875320 | 2" Receiver

RAMPS & COVERS

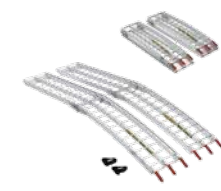

FOLDING HEAVY-DUTY ALUMINUM ARCHED RAMPS

- Fold up for transport
- Strong enough to hold up to 1,500 lb. (680.7 kg)
- Include safety straps and instructions
- Sold in pairs

▶ 2875387



ALUMINUM ARCHED LOADING RAMPS

- Each ramp measures 76" x 12" (23.2 x 30.5 cm)
- Combined capacity up to 2,000 lb. (907.2 kg)
- Easily transportable
- Sold in pairs

▶ 2875384

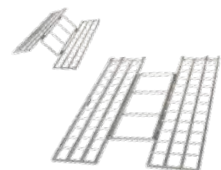

LIGHTWEIGHT TRI-FOLD RAMP

- Handles up to 1,500 lb. (680.7 kg)
- Folds up to fit under ATV during transport
- Includes safety straps and instructions

▶ 2875385 | 72" x 51"
▶ 2875860 | 82" x 51"



TRAILERING COVER

- Strong, durable, weatherproof canvas construction
- Canvas is UV-stable to resist fading from prolonged exposure to sunlight
- Designed specifically for the Sportsman® so it goes on and off easily, fits properly, and offers reliable, full-coverage protection
- Ratchet strap system on the bottom secures the cover to the vehicle
- Cover features expandable pockets that ensure coverage of accessories such as all bumpers, roof, most rear cargo box accessories and more

▶ 2876614

ALL SPORTSMAN® (EXCEPT 300/400, X2, SPORTSMAN® TOURING)

▶ 2877999

ALL SPORTSMAN® TOURING

▶ 2877998

SPORTSMAN® X2

PARTS

DO RIGHT BY YOUR MACHINE.

Polaris Engineered Parts™ are rigorously tested, developed specially for your machine and optimized for peak performance. Look to do right by your machine, so it will do right for you by using only Polaris Engineered Parts™.



AIR FILTERS

- In extreme stress tests, blocked 99.9% of dirt and contaminants
- Blocks 32% more dirt and contaminants than the closest competitor

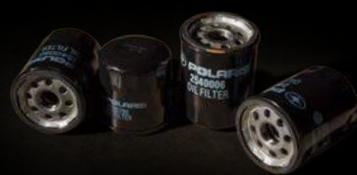

OIL FILTERS

- 44% less restriction than our competitors' oil filters, providing appropriate lubrication in any condition
- Designed to keep strong oil flow in the most demanding conditions
- Allows optimal oil flow for cold starts



BATTERY

- Designed, tested and improved to provide the high output needed in our high performance vehicles
- Guaranteed to fit in your machine & perform the way you demand it to



BRAKE PADS

- Designed and tested to perform in all conditions: humid, wet or dry, hot or cold
- Features sintered metallic pads to ensure optimal performance at extreme operating temperatures
- Engineered for maximum output and minimal noise and wear



DRIVE BELTS

- Lowest tolerance available (.188") means our belts have the least variation allowed in width and length, resulting in consistently higher performance
- All belts undergo at least 20,000 miles of vehicle testing and 1,500 hours of runtime in a dynamometer
- Made from Kevlar, our belts continue to perform and outlast other belts

2016 PARTS FIT CHART

VEHICLE	AIR FILTER	BELT	OIL FILTER	BATTERY	BRAKE PAD FRONT	BRAKE PAD REAR
Sportsman® 850 / Sportsman® 850 SP / Sportsman® Touring 850 / Sportsman XP® 1000 / Sportsman® Touring XP 1000 / SCRAMBLER® 850 / SCRAMBLER® XP 1000	» 7082101	» 3211160	» 2520799	» 4011496	» 2203628	» 2203628
Sportsman® 850 High Lifter Edition / Sportsman XP® 1000 High Lifter Edition	» 7082101	» 3211160	» 2520799	» 4011496	» 2205606	» 2205606
Sportsman® 570 / Sportsman® 570 EPS / Sportsman® TOURING 570 / Sportsman® X2 570 EPS	» 7082101	» 3211113	» 2520799	» 4140006	» 2202412	» 1911292
Sportsman® 570 SP / Sportsman® TOURING 570 SP	» 7082101	» 3211113	» 2520799	» 4011138	» 2202412	» 1911292
Sportsman® ETX / Sportsman® ETX EPS	» 7082101	» 3211077	» 2521231	» 4140006	» 2202412	» 1911292
OUTLAW® 110 EFI / SPORTSMAN® 110 EFI	» 0454620	» 0453455	-	» 4011181	» 0450422	» 0450434

FOR A COMPLETE LISTING OF PARTS VISIT POLARIS.COM

FUEL TREATMENTS

PROVEN PERFORMANCE

PRODUCT	FUEL SYSTEM CLEANER	CORROSION PROTECTION	STABILIZES FUEL	COMBUSTION CLEANUP	ALCOHOL FREE
CARBON CLEAN	✓	✓	✓	✓	✓
ADVANCED FUEL TREATMENT		✓	✓		✓
AFTERMARKET 1					
AFTERMARKET 2	✓	✓			✓
AFTERMARKET 3					

Fuel treatments containing alcohol may be corrosive to critical engine components. All Polaris Engineered Lubricants™ fuel treatment products are alcohol free. Competitive products evaluated by third party testing facility using ASTM testing standards.



SCENTED ADVANCED FUEL TREATMENT / NEW

- New 1oz pouch treats 5 gallons of fuel
- Scented Strawberry and Mint formulas provide pleasant fragrance through the exhaust system
- Alcohol free: safe for all powersports applications
- Ethanol compatible
- » 2881419 | 25-1 oz. | Strawberry
- » 2881418 | 25-1 oz. | Mint
- » 2881420 | 25-1 oz. | Unscented
- » 2881421 | 75-1 oz. pouches | 3 Pack Kit - 25 each formula



CARBON CLEAN / NEW

- New advanced formula with 5:1 powersports treat ratio
- Ultimate fuel and injection system cleaner
- Removes carbon deposits from valves, piston rings, and combustion chamber
- Alcohol free: safe for all powersports applications
- Ethanol compatible
- » 2881413 | 12 oz. | 12 per case



ADVANCED FUEL / NEW TREATMENT

- New advanced formula with 5:1 powersports treat ratio
- Dual Antioxidant formula protects jets and fuel system from gum and varnish
- Stabilizes fuel for up to 2 years
- Alcohol free: safe for all powersports applications
- Ethanol compatible
- » 2881416 | 12 oz. | 12 per case
- » 2881417 | 2.5 gal. | 2 per case

VEHICLE CARE

PRE-TREAT

MUD SHIELD™ PRE TREATMENT

- Pre-treat and protect, engineered for the most extreme conditions
- Makes cleaning your vehicle easier and faster
- Inhibits the adhesion of dirt, mud and snow
- » 2830229

NEVER RUST SPRAY™

- Brutal conditions demand superior protection, be prepared for any climate before and after you ride
- Synthetic formula protects against rust and corrosion while lubricating metal surfaces
- High resistance to water wash out
- » 2830230

CLEAN

XP WASH™

- Removed the most intense and stubborn dirt and trail build up easily
- A foaming, highly concentrated wash
- Superior water beading
- » 2830225

XP SPRAY WASH™

- Effortless cleaning power - simply spray on, spray off and go
- A biodegradable, high-performance wash ideal for removing dirt, oils and carbon build up
- » 2830224

GLASS CLEANER / NEW

- Heavy-duty foam formula clings to vertical surfaces
- Leaves an invisible, dirt resistant barrier for long lasting results
- Non-streak formula leaves glass surfaces crystal clear
- Cuts through grease, dirt, road-film and dried on bugs
- Cleans and brightens all glass surfaces
- » 2830443

ALL PURPOSE CLEANER

- Heavy-duty foam formula clings to vertical surfaces
- Leaves an invisible, dirt resistant barrier for long lasting results
- Non-streak formula leaves glass surfaces crystal clear
- Cuts through grease, dirt, road-film
- » 2830227

HD CLEANER & DEGREASER / NEW

- Professional grade formula
- Quickly dissolves and removes tough stains and soils from surfaces
- High foaming for optimum contact and penetration
- Biodegradable and contains no harsh acids
- » 2830418 | 1 gal.
- » 2830420 | 5 gal.

VEHICLE & EQUIPMENT WASH / NEW

- Professional grade formula
- Powers through vehicle buildup such as dirt, trail grime, and grease
- Leaves a spot free rinse on all surfaces
- Concentrated formula treats up to 32 gallons
- Biodegradable
- » 2830417 | 1 gal.
- » 2830422 | 5 gal.

ALL PURPOSE CLEANER PLUS / NEW

- Professional grade formula
- Removes built up stains from shop floors, work benches and other hard surfaces
- All-purpose formula is VOC-free, environmentally friendly and biodegradable
- Contains no chlorine, phosphates, solvents or abrasive chemicals
- » 2830414 | 1 gal.
- » 2830416 | 5 gal.

SHINE

POLARIS® POLISH

- Protection and shine have never looked so good or been so easy - spray on, wipe off and go
 - Ideal on painted and plastic surfaces
 - Contains carnauba wax
 - » 2830228
- ### INSTANT SHINE & DETAILER
- Cleans, polishes and protects plastic and painted surfaces
 - Be quick, be effective, be ready to go
 - Spray and wipe formula
 - » 2830226





THE ONLY OIL DEVELOPED WITH AND FOR YOUR ENGINE.

Only Polaris Engineered Lubricants™ are specially developed with Polaris® engines to handle the intense conditions and high-performance requirements demanded by riders worldwide. In independently verified testing, engines running for 75 hours, engines using PS-4 showed 24% less wear in crucial engine parts compared to traditional name-brand automotive oil, while consuming 19% less oil. Trust the only oil perfectly engineered for your Polaris® vehicle.

PS-4 FULL SYNTHETIC OIL

- Optimal ambient temperature operating range: -40° F to 100° F
- Maintains critical cold flow characteristics down to -40° F
- Designed specifically for Polaris® 4-cycle engines
- High film strength and wear protection under extreme loads and extreme cold temperatures
- Exclusive anti-wear additives protect engine parts
- Extra rust and corrosion protection



OIL CHANGE KITS

- » 2882166 POLARIS ACE® 570, RZR®/RANGER® 570, TWIN 600, 700, 800
- » 2877473 SPORTSMAN® 330-570, XP 550/850/1000
- » 2880913 RANGER®/SPORTSMAN® ETX, POLARIS ACE™
- » 2879323 RANGER® XP 900, RZR® 900/1000
- » 2879129 RZR® XP MY11-12
- » 2881696 / **NEW** RZR® XP TURBO MY16

Contains the specific amount of oil for your machine, correct filter and mileage sticker



- » 2876244 | 1 qt. | 12 per case
- » 2877490 | 2 qt. | 8 per case
- » 2876245 | 1 gal. | 4 per case
- » 2876247 | 16 gal. drum
- » 2876246 | 55 gal. drum
- » 2878814 | 330 gal. tote

PS-4 EXTREME DUTY FULL SYNTHETIC OIL

- Optimal ambient temperature operating range: 0° F to 130° F
- Designed specifically for Polaris® 4-cycle engines
- High film strength and wear protection under extreme loads and extreme high temperatures
- Exclusive anti-wear additives protect engine parts
- Extra rust and corrosion protection



OIL CHANGE KITS

- » 2879004 POLARIS ACE® 570, RZR®/RANGER® 570, TWIN 600, 700, 800
- » 2878924 SPORTSMAN® 330-570, XP 550/850/1000
- » 2879324 RANGER® XP 900, RZR® 900/1000
- » 2879130 RZR® XP MY11-12
- » 2881697 / **NEW** RZR® XP TURBO MY16

Contains the specific amount of oil for your machine, correct filter and mileage sticker



- » 2878920 | 1 qt. | 12 per case
- » 2878922 | 2 qt. | 8 per case
- » 2878919 | 1 gal. | 4 per case
- » 2879003 | 16 gal. drum
- » 2879002 | 55 gal. drum
- » 2879001 | 330 gal. tote

PS-4 FULL SYNTHETIC VS AUTOMOTIVE OIL

39% GREATER VISCOSITY RANGE

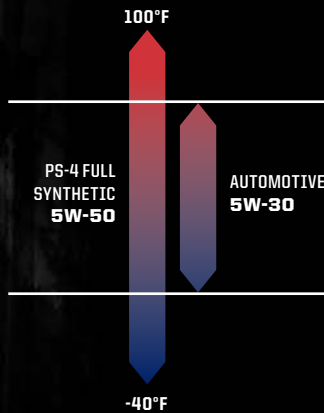

- Industry-leading viscosity range
- 5W provides optimal cold-start protection
- 50 provides maximum film strength in high-heat, high-stress conditions

24% BETTER WEAR PROTECTION



- Anti-wear additives bond to critical motor internals for wear prevention
- High detergency prevents sludge & carbon buildup

19% HIGHER OIL RETENTION



- Full synthetic base stock
- Low volatility keeps oil in the crankcase

TIP: FOR PEAK ENGINE PERFORMANCE & EXTENDED VEHICLE LIFE, REMEMBER TO CHANGE YOUR OIL EVERY 6 MONTHS*

*See owner's manual for your vehicles recommended maintenance interval.



ANGLE DRIVE FLUID

- Extreme pressure, anti-wear, high viscosity film lubrication
 - Maximum protection of Polaris front & right angle drives
 - Excellent corrosion protection
 - Ensures long component life under severe operating conditions
- » 2876160 | 1 qt. | 12 per case
» 2872276 | 2.5 gal. | 2 per case



AGL

- Full synthetic friction-reducing formulation, extreme pressure film protection for severe operating temperatures
 - Prevents rust, oxidation, foam and corrosion of internal ATV transmission components
- » 2878068 | 1 qt. | 12 per case
» 2878069 | 1 gal. | 4 per case
» 2878070 | 2.5 gal. | 2 per case
» 2879594 | 55 gal. drum



DEMAND DRIVE

- Formulated for lubricity, corrosion and oxidation protection in all operating conditions
 - Replaces Demand Drive Fluid, LT Demand Drive Fluid, and ADC Fluid
- » 2877922 | 1 qt. | 12 per case
» 2877923 | 2.5 gal. | 2 per case



ORV MAINTENANCE KIT / NEW

- Kit includes:
 - 1.5 qt.s of AGL
 - 1 qt. of Angle Drive Fluid
 - 1 pint of Demand Drive Fluid
 - 1 3oz. tube of All-Season Grease
 - Services RANGER®, RZR®, Sportsman®, Polaris ACE™
- » 2880425



EXTENDED LIFE ANTI-FREEZE 50/50 FORMULATION

- Extended 5-year service internal
 - New organic acid technology
 - Hard water compatible
 - No scaling = better heat transfer
 - New yellow coloration
- » 2880514 | 1 qt. | 12 per case
» 2880513 | 1 gal. | 6 per case
» 2880512 | 55 gal. drum



BRAKE FLUID

- Designed for use in Polaris® hydraulic brakes
 - Superior high temperature characteristics
 - Anti-corrosive additives extend the life of brake system and ensure consistent, positive braking
- » 2872189 | 12 oz. | 12 per case



SYNTHETIC DIESEL ENGINE OIL

- All-Season 5W-40 Formula
 - Excellent cold weather protection
 - Ultimate protection in serve duty applications
- » 2879832 | 1 qt. | 12 per case



SUMMER 15W40 DIESEL OIL

- Multi grade lubricant designed for heavy duty equipment
 - Excellent wear protection during high temperature applications
- » 2878473 | 2 qt. | 8 per case



LOCTITE® RED THREADLOCKER STICK HIGH STRENGTH

» 2830364

LOCTITE® GASKET MAKER 518

» 2830327

LOCTITE® 243 BLUE THREADLOCKER STICK MEDIUM STRENGTH

» 2830362

LOCTITE® RTV 598 BLACK

» 2830233

LOCTITE® THREAD SEALANT STICK

» 2830236



GREASE GUN KIT

- Tough steel construction and pistol grip design
 - Front and top-pipe outlet mounts accept both 6" rigid pipe nozzle and 12" 12,000 psi flex hose
 - Comes with standard zerk fitting
- » 2871312 | 4 per case



ALL-SEASON GREASE

- High shear stability
 - Superior adhesion
 - Multi-purpose formulation for all Polaris® applications except U-joints
 - Low temperature pliability for protection at cold start-up as well as excellent high speed and high temperature protection
- » 2871322 | 3 oz. 4-pack | 6 per case
» 2871423 | 14 oz. | 10 per case



U-JOINT GREASE

- Increases U-joint life
 - Extremely water resistant
 - Molybdenum additive cushions shock-load in U-joint applications
 - High shear stability
 - Superior adhesion
- » 2871515 | 3 oz. 4-pack | 24 per case
» 2871551 | 14 oz. | 10 per case



OFF-ROAD ENGINES DEMAND OIL ENGINEERED FOR THE OFF-ROAD.

Only Polaris Engineered Lubricants™ are developed with Polaris® engines to keep your Sportsman® operating at full capacity in any environment.

In addition to a full line of accessories and apparel, Polaris® offers a complete line of financing and service contract options. See your dealer for more info.

MY16 Sptsmn Aprri Accessory Intl | MY16 Sptsmn Aprri Accessory INTL | 9930159

Intl | 9930159



The only extended coverage straight from Polaris®—compromise nothing.
www.proctectmypolaris.com

All riders pictured are trained professionals. Polaris® recommends that all riders take a training course. Do not attempt maneuvers beyond your capability. Always wear a helmet and other safety apparel. Never drink and ride. All off-road vehicles depicted in this brochure may feature Polaris® parts and accessories and are not standard features of the base models they accompany. All performance and/or feature and benefit claims are based upon competitive data available at time of printing. For your nearest dealer, call 1-800-POLARIS or go to www.polaris.com. Polaris Sales Inc., 2100 Hwy. 55, Medina, MN 55340 (763) 542-0500 Fax (763) 542-0599 Polaris Industries Ltd. 50 Prairie Way, Winnipeg, Manitoba, Canada R2J 3J8 (204) 925-7100 Fax (204) 925-7110

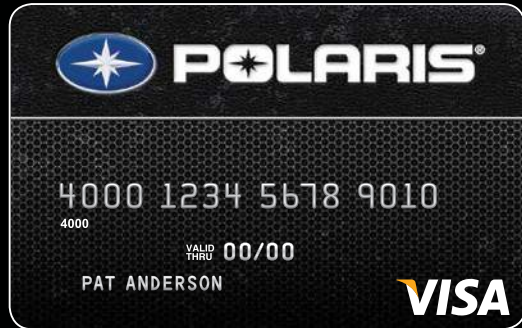

EARN \$50 POLARIS® CASH WITH YOUR FIRST PURCHASE AND TAKE THE TRAIL MORE REWARDED.



The creditor and issuer of the Polaris® Visa card is U.S. Bank National Association, pursuant to a license from Visa U.S.A. Inc. © 2015 U.S. Bank National Association. All rights reserved.

Unless noted, trademarks are the property of Polaris® Industries Inc. 509® is a registered trademark of 509, Inc. Amara® is a registered trademark of Kuraray Co. Ltd. of Japan. AP-360® is a registered trademark of TK. Bighorn® is a registered trademark of Cheng Shin Rubber USA, Inc. Bluetooth® is a registered trademark of Bluetooth Sig. Inc. Break-Up® is a registered trademark of Haas Outdoors, Inc. Browning® is a registered trademark of Browning Corporation. ChatterBox™ is a trademark of ChatterBox USA. Cordura® is a registered trademark of Invista North America S.A.R.L. Daewoo® is a registered trademark of Daewoo International Corporation. Fly F2® is a registered trademark of Western Power Sports, Inc. Fly Racing® is a registered trademark of Western Power Sports, Inc. FXR® is a registered trademark of Factory Racewear. iPhone® and iPod® are registered trademarks of Apple Computer, Inc. ITP® is a registered trademark of Carlisle Intangible Company. Jensen® is a registered trademark of Recoton Audio Corp. JL Audio® is a registered trademark of JL Audio, Inc. Kevlar® is a registered trademark of DuPont. Kolpin® is a registered trademark of Kolpin Outdoors, Inc. Lowrance® is a registered trademark of Navico, Inc. Lycra® is a registered trademark of INVISTA North America S.A.R.L. Maxxis® is a registered trademark of Cheng Shin Rubber Ind. Co., Ltd. Mossy Oak® is a registered trademark of Haas Outdoors, Inc. Nivomat® is a registered trademark of ZF Sachs AG. OBG10® is a registered trademark of Ogio International, Inc. PIAA® is a registered trademark of PIAA Corporation. Polyfil® is a registered trademark of J & P Coats Limited Corp. Quick-Dry® is a registered trademark of Innovative Fashion Group Corp. SAE® is a registered trademark of Society of Automotive Engineers, Inc. Sedona® is a trademark of Western Power Sports, Inc. Sirius® is a registered trademark of Ampspeaker APS Corporation. SIXR® is a trademark of Cheng Shin Rubber Ind. Co., Ltd. Snell® is a registered trademark of Snell Memorial Foundation, Inc. SSV WORKS® is a registered trademark of SSV Works, LLC. TekVest® is a registered trademark of Tekrider, Inc. Velcro® is a registered trademark of Velcro Industries B.V. Ltd Co. Netherlands. Walker Evans® is a registered trademark of Walker Evans Racing. WARN® is a registered trademark of WARN® Industries, Inc. YKK® is a registered trademark of YKK Corporation. Prices and availability are subject to change at any moment. Copyright © 2015 Polaris® Industries. All rights reserved.